

Interconnection Order No. 2023 Compliance Plan and Tariff Review

Thinh Nguyen

Senior Manager, Interconnection Projects

Interconnection Issues Task Force (IITF)

March 15, 2024

Agenda

- **Tariff Review Schedule**
- **Overview of Interconnection Procedures in the Current Tariff**
- **Overview of New NYISO Interconnection Procedures – OATT Attachment HH – and Conforming Tariff Revisions**
 - Updated and new tariff revisions are posted with the meeting materials
- **Conceptual Changes to the Compliance Plan since the March 1, 2024 IITF Meeting**
- **Next Steps**

Tariff Approach

- **At the December 14, 2023, Operating Committee (OC) meeting, the NYISO presented to stakeholders its comprehensive compliance plan for Order No. 2023, which presentation is attached as Appendix A.**
 - The NYISO has modified aspects of the compliance plan presented on December 14, 2023 in response to stakeholder feedback. Any such modifications will be identified in upcoming meetings.
- **The NYISO has posted draft tariff language to implement this comprehensive plan on February 6, 2024, February 16, 2024, March 1, 2024, and March 15, 2024.**
- **Conceptual changes/revisions from the 3/1 IITF Presentation and discussion points for today's meeting are noted in red.**

Interconnection Procedures – Current Tariff

Interconnection Procedures in Current NYISO OATT

- **The NYISO's interconnection procedures for generating facilities and transmission projects subject to the Class Year are currently established across multiple attachments of the OATT**
 - Att. S – Rules to Allocate Responsibility for the Cost of New Interconnection Facilities;
 - Att. X – Standard Large Facility Interconnection Procedures; and
 - Att. Z – Small Generator Interconnection Procedures.
- **The NYISO OATT contains separate interconnection requirements for Transmission Projects in OATT Att. P and for transmission expansion and load projects in the body of the OATT.**

New NYISO Interconnection Procedures - Attachment HH

New OATT Attachment HH

- **New OATT Attachment HH includes the interconnection procedures for the new Cluster Study Process – the Standard Interconnection Procedures.**
 - Attachment HH will consolidate the existing requirements from OATT Attachments S, X, and Z, as revised for the new Cluster Study Process and compliance with Order No. 2023.
 - Attachments S, X, and Z will remain in the tariff for the limited purposes of the NYISO’s completing Class Year 2023 and performing the transition to the new Cluster Study Process.
- **The NYISO is not proposing revising its Transmission Interconnection Procedures in Attachment P to the OATT or the transmission expansion rules in the body of the OATT, except for any conforming revisions needed to account for the new Attachment HH rules.**

New OATT Attachment HH

- As detailed in the following slides, new Attachment HH uses the general structure of the current Standard Large Facility Interconnection Procedures in Attachment X as revised to incorporate:
 - New Cluster Study Process elements;
 - Applicable rules from Attachments S and Z; and
 - Order No. 2023 *pro forma* revisions.
- As the new Cluster Study mirrors in large part the current Class Year Study, many of the existing Class Year Study and related cost allocation requirements in OATT Attachment S will remain largely the same in Attachment HH
 - Revisions to these provisions (including the Existing System Representation, ATBA, ATRA, Class Year Deliverability Study, Additional SDU Study, and headroom rule) are required to align with the new process elements, including more explicit separation between the Phase 1 (formerly Part 1) and the Phase 2 (formerly Part 2) studies.
- The existing, stand-alone Small Generator Interconnection Procedures will largely be replaced by the new procedures.
 - The Fast Track Process and 10 kV Inverter Process will be included in the new Attachment HH.

New OATT Attachment HH Structure

- 40.1 – Definitions
 - Consolidated definitions from Attachments S, X, and Z and Order No. 2023
 - Revised Definitions (Initial Backfeed Date (renamed from In-Service Date), Phase 2 Study Start Date, and minor corrections)
- 40.2 - Effective Date, Scope, and Application of Standard Interconnection Procedures
 - New rules and rules from Att. X 30.2 and Att. S 25.10
 - Deleted no longer applicable transition rule from Transmission Interconnection Procedures
- 40.3 - Transition Rules
 - New rules and rules from Att. X 30.5
- 40.4 - Pre-Cluster Study Process Procedures (i.e., Heatmap and Pre-Application Report)
 - New rules and rules from Att. Z 32.1 and Order No. 2023 Pro Forma 6.1
- 40.5 - Cluster Study Process Start Date/ Application Window/ Interconnection Requests/ Interconnection Service Options
 - New rules and rules from OATT 30.3 and Order No. 2023 Pro Forma 3.4.2
 - Clarified impact on Contingent Projects if Additional SDU Study is not completed
 - Established process for execution of Cluster Study Agreement following validation of Interconnection Request/CRIS-Only Request

New OATT Attachment HH Structure (cont.)

- 40.6 - Queue Position/ Modification/ Withdrawal/ Withdrawal Penalties
 - New rules and rules from OATT 30.3 and 30.4
 - **Included completion of applicable permitting process as additional mechanism to demonstrate reasonable progress to extend Commercial Operation Date**
 - **Inserted FERC pro forma requirement that NYISO post balance of not yet dispersed withdrawal penalty funds on its website**
- 40.7 - Customer Engagement Window (including Cluster Study Project List, Scoping Meeting, and Physical Infeasibility Screening)/ Phase 1 Entry Decision Period
 - New rules and rules from OATT 30.3 and Order No. 2023 Pro Forma 3.4.5.
 - **Included additional items NYISO will include in Customer Study Project List (e.g., CTO/ATO, resource type includes combined resources).**
 - **Provided that Physical Infeasibility Screening does not establish TO obligation to acquire real property.**
- 40.8 - Affected Systems within New York Control Area and External Affected Systems
 - New rules and rules from OATT 30.3 and Order No. 2023 Pro Forma 3.6 and 9.
 - **Clarified certain Affected System Study process requirements**
- 40.9 - Cluster Study Overview/ NYISO Minimum Interconnection Standard/ NYISO Deliverability Interconnection Standard/ Cluster Study Cost Allocation Rules
 - New rules and rules from Att. X 30.3 and Att. S 25.1, 25.2, 25.4 and 25.5
 - **Included updates to timeframe description and study metrics/information reporting**

New OATT Attachment HH Structure (cont.)

- 40.10 - Phase 1 Study/Existing System Representation/ Annual Transmission Baseline Assessment / Phase 1 Study Scope and Procedures/ Phase 2 Entry Decision Period
 - New rules and rules from Att X 30.8 and Att. S 25.5, 25.6
 - **Clarified certain NYISO and TO responsibilities for performance of elements of Phase 1 Study process**
- 40.11 - Phase 2 Study / Annual Transmission Reliability Assessment
 - New rules and rules from Att X 30.8 and Att. S 25.5, 25.6
 - **Clarified certain NYISO and TO responsibilities for performance of elements of Phase 2 Study process**
- 40.12 – Cluster Baseline Assessment (CBA) and Cluster Project Assessment (CPA) (formerly “ATBA and ATRA”)
- 40.13- Cluster Study Deliverability Study
 - Rules from Att. S 25.7
- 40.14 - Additional SDU Study
 - Rules from Att. S 25.5
 - **Determined to retain new Byway SDUs in Additional SDU Study process**
 - **Clarified that when Additional SDU Study includes more than one SDU, NYISO can proceed with separate Additional SDU Study Decision Periods for such SDUs.**

New OATT Attachment HH Structure (cont.)

- 40.15 - Final Decision Period/ Additional SDU Study Decision Period
 - New rules and rules from Att. S 25.8
 - Clarified deposit and penalties rules for projects in Additional SDU Studies not completed in Cluster Study Process
- 40.16 - Security Forfeiture; Future Cost Responsibility
 - Rules from Att. S 25.8
- 40.17 - Headroom Rules
 - Rules from Att. S 25.8
- 40.18 - CRIS Retention, Expiration, Transfer and External CRIS (formerly “Going Forward Rules”)
 - Rules from Att. S 25.9
- 40.19 - Expedited Deliverability Study Procedures
 - Rules from Att. S 25.5
- 40.20 - Engineering & Procurement Agreement
 - Rules from Att. X 30.9

New OATT Attachment HH Structure (cont.)

- **40.21 - Standard Interconnection Agreement (IA)/ Standard Upgrade Construction Agreement/ Standard Multiparty Upgrade Construction Agreement**
 - New rules and rules from Att. X 30.11
- **40.22 - Construction of Connecting Transmission Owner's Attachment Facilities, System Upgrade Facilities, and System Deliverability Upgrades**
 - Rules from Att. X 30.12
- **40.23 - Fast Track Process**
 - Rules from Att. Z 32.2
- **40.24 - Miscellaneous**
 - Rules from Att. X 30.13
 - **Clarified that NYISO will participate in dispute resolution procedures between other parties to assist those parties in resolving claim or dispute**

New OATT Attachment HH Structure (cont.)

- Appendices

- Interconnection Request Form [Rules from Att. X Appendix 1];
 - Added information Order 2023 required developers to provide concerning non-synchronous resources (described in Slide 133).
 - Added confirmation Interconnection Customer must provide with submission of request.
- Cluster Study Agreement
- Pre-Application Request Form and Pre-Application Report Template [Rules from Small Gen Pre-Application Materials];
- CRIS-Only Request Form
 - Added confirmation Interconnection Customer must provide with submission of request.
- Two-Party and Multiparty Affected System Study Agreements [Rules from FERC Order 2023 Pro Forma Appendices 9 and 10];
- Facility Modification Form and Terms and Conditions [Rules from Att. X Appendix 3];
- Expedited Deliverability Study Agreement [Rule from Att. S Appendix 2];
- Allocation of Overage Cost Example [Rules from Att. S Appendix 1];

New OATT Attachment HH Structure (cont.)

- Appendices

- Pro Forma Standard Interconnection Agreement [Rules from Att. X Appendix 4];
 - Clarified description of work performed under construction agreements [Art. 11.4]
- Standard Upgrade Construction Agreement and Standard Multiparty Construction Agreements [New];
 - Clarified language regarding System Owner's and developer's ability, at System Owner's discretion, for developer(s) to construct the Upgrades, including providing in multi developer agreement for joint and several liability of developers when multiple developers agree to perform such work
 - Added FERC pro forma tax provisions
 - For multi-party agreement, establish the requirements by which the agreement can continue if one or more, but not, all developers participating in the agreement are subject to the termination under the agreement.
- Certification Code and Standards [Rule from Att. Z Appendix 3];
- Certification of Facility Equipment Packages [Rule from Att. Z Appendix 4];
- 10k Inverter Process [Rules from Att. Z Appendix 5];
- Fast Track Request Form

Conforming OATT and Services Tariff Revisions

Conforming OATT and MST Revisions

- In connection with the new Standard Interconnection Procedures in Attachment HH and related changes to the procedures and terminology, the NYISO has made certain conforming revisions and updated defined terms and cross references in other provisions in the OATT and Services Tariff.
 - Existing Interconnection Procedures (OATT Atts. S, X, and Z/§§ 25, 30, and 32) – NYISO updated to provide for replacement of these procedures by Attachment HH subject to the transition rules in Att. HH 40.3. NYISO also updated Small Generator Interconnection Agreement to address Order No. 2023 revisions, which agreement will continue to be used for developers completing Small Generator facilities studies.
 - Transmission Interconnection Procedures (OATT Att. P/§ 22) – NYISO made conforming revisions to align definitions and defined terms, to update cross-references, to align certain Existing System Representation rules with Att. HH rules, to align the treatment of Transmission Projects on External Affected Systems with the new Att. HH rules, and to account for the updated Standard Interconnection Procedures and new construction agreements
 - Transmission Planning Requirements (OATT RS10, Att. Y, and FF/§§ 6.10, 31 and 38) – NYISO made conforming revisions to align defined terms, to update cross-references, and to update the description of the interconnection requirements that a competitive transmission project subject to the new Cluster Study Process must satisfy in the competitive transmission planning process.

Conforming OATT and MST Revisions (cont.)

- Buyer Side Mitigation/Market Mitigation rules (MST Att. H and O/§§ 23 and 30) – NYISO made conforming revisions to align definitions and defined terms and to update requirements tied to Class Year deadlines with analog deadlines in new Cluster Study Process.
- OATT Load/Facility Interconnection Procedures (OATT 3.9, 3.10, 3.11, and 4.5) – NYISO updated description of Load and Large Facility interconnection procedures in body of the OATT to clarify that proposed interconnections of Facilities are addressed pursuant to the OATT Attachment HH rules.
- Additional revisions to OATT Sections 1.4, 6.12, 6.16, 19.2 and to MST Sections 2.5, 2.12, 5.12, 5.16, 5.18, 11, and 15.5 to update defined terms and cross-references and to update requirements tied to Class Year deadlines with analog deadlines in new Cluster Study Process.
- **Added Order No. 2023 required updates to NYISO's *pro forma* Large Generator Interconnection Agreement that will continue to be used for Class Year 2021 (or prior Class Year) projects.**

Key Conceptual Changes from March 1, 2024 IITF Presentation

***indicated in red**

Cluster Study Process – Overview

Cluster Study Process

■ Key Aspects:

- An overall timeline that aligns with the timeline laid out in Order No. 2023;
- A rolling, optional Pre-Application process;
- An enhanced scope for the Customer Engagement Window (including a physical infeasibility screen);
- A two-phase Cluster Study that incorporates SRIS-type analyses and Class Year analyses (including POI upgrades) rather than an SRIS-type cluster study and re-study followed by an individual facilities study;
- Limited project modifications and opportunities to cure deficiencies;

Cluster Study Process

■ Key Aspects, cont.:

- Inability for projects to move forward if deemed physically infeasible;
- Increased financial commitments, including study deposits and commercial readiness deposits largely aligned with those in Order No. 2023;
- Withdrawal penalties;
- More stringent Site Control requirements; and
- Incorporating Small Generating Facilities into the Cluster Study Process.

Cluster Study Process – Structure and Timeline

Cluster Study Process

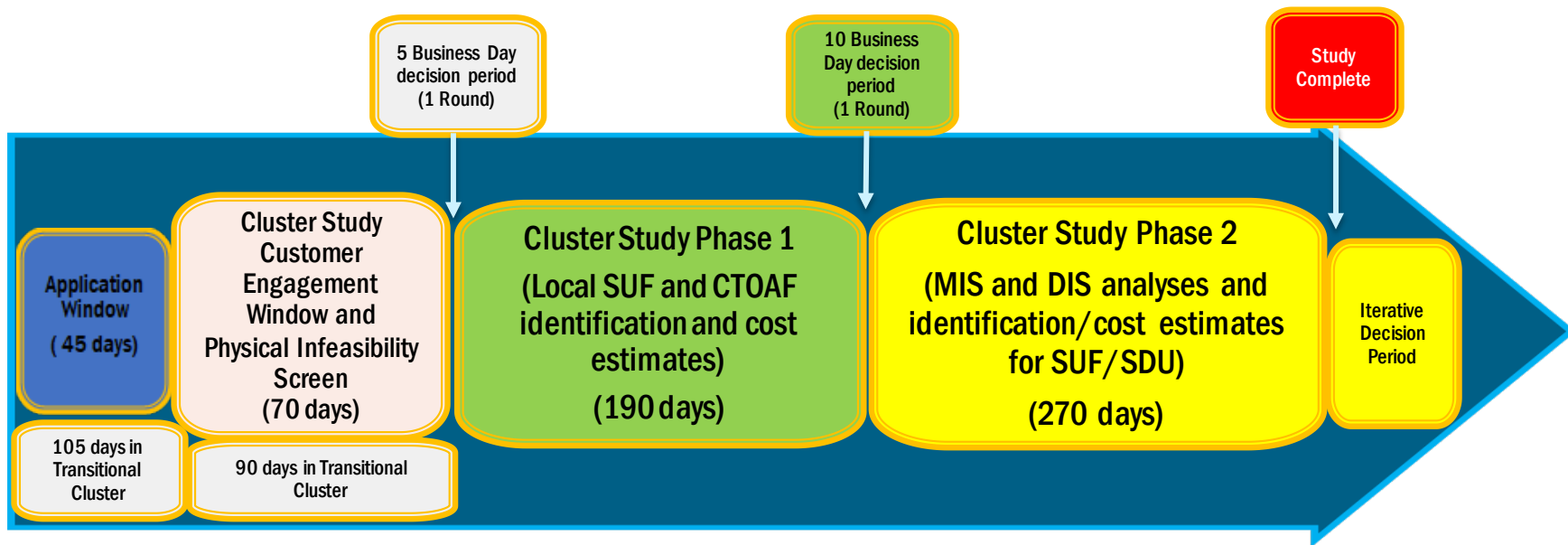

Total Timeline: 590 days (1.6 years)

Total Timeline in Order No. 2023: 495 days to 585 days (1.4 - 1.6 years)

Cluster Study Process

Pre-work to prepare for Cluster Study Phase 1 and Phase 2

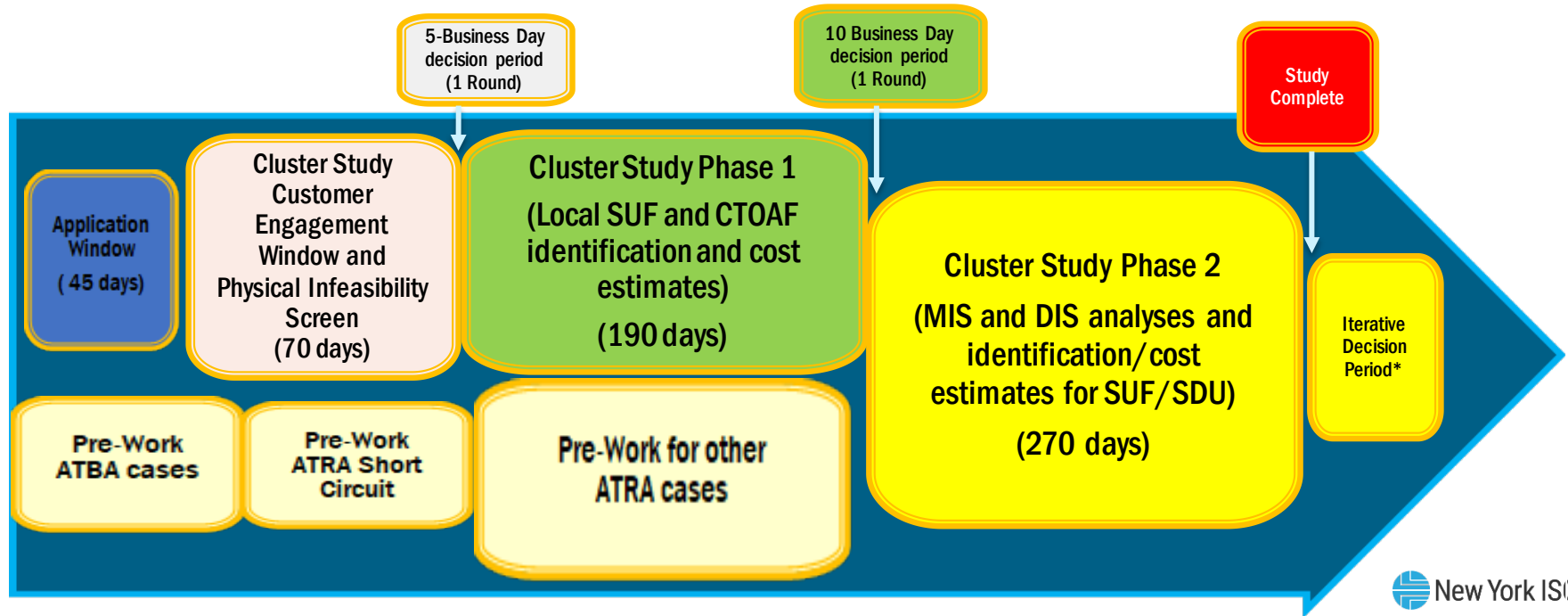

NYISO Proposed Cluster Study Process Overview

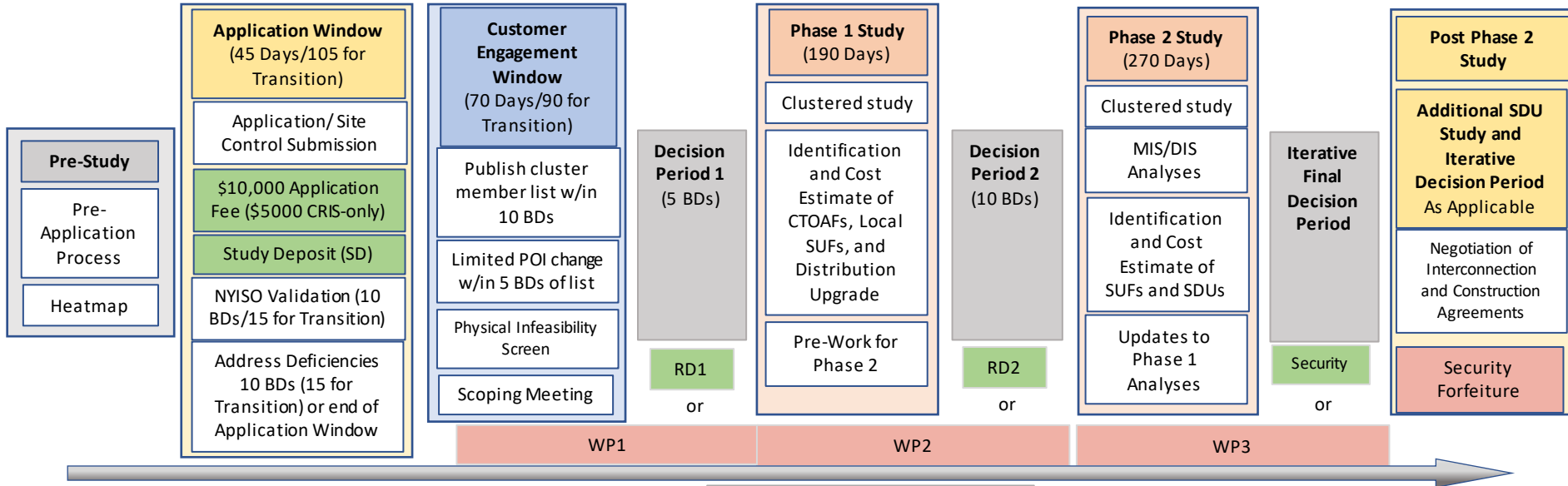

Study Deposit (SD) Amounts

Readiness Deposits (RD) /Security Amounts

Withdrawal Penalty (WP) Amounts

Size	Amount
< 80 MW	\$100,000
≥ 80 < 200 MW	\$150,000
≥ 200 MW	\$250,000
CRIS Only	\$50,000

Deposit	Amount
RD1*	\$4,000/MW
RD2*	The greater of (i) RD1, and (ii) 20% of cost estimate determined in Phase 1 for Local SUF and CTOAF
Security	100% of cost estimate of SUFs, SDUs, and CTOAFs identified in Phase 1 and Phase 2

Penalty	Amount
	If a project withdraws during the Application Window or up to within 5 Business Days of the NYISO publishing the cluster member list in the Customer Engagement Window, there is no withdrawal penalty. Also, no withdrawal penalty for contingent projects and projects that withdraw due to physical infeasibility
WP1	25% of SD, except if withdrawal is of a contingent project or due to physical infeasibility
WP2	50% of SD + 10% of RD1, except if withdrawal is due to physical infeasibility
WP3	100% of SD + 20% of RD2, except if withdrawal is due to physical infeasibility or if there has been a 50% cost increase between Phase 1 and Phase 2 (non SDU) costs.
Security Forfeiture	Up to 100% of Security subject to forfeiture if other projects relying on the upgrades identified for its project

* N/A to CRIS only projects

Sequencing of Cluster Studies

- Clusters begin approximately every 18 months with slight overlap, but not overlap that would cause rework or inefficiencies

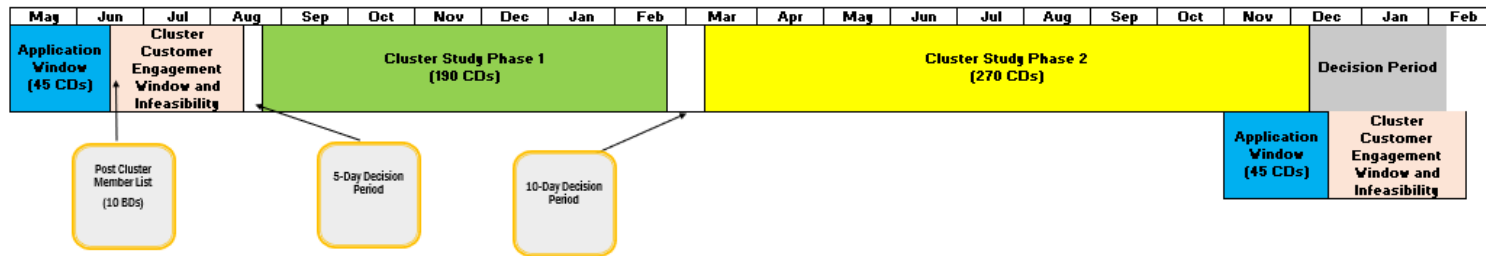

Interim Transition Rules

Interim Transition Rules

- **NYISO filed a partial compliance filing/waiver on November 3, 2023 to establish interim transition rules to expedite the efficient transition to the new Cluster Study process. Specifically, the transition rules:**
 - Eliminate the SRIS requirement for pending queue projects;
 - Eliminate the option to elect a detailed Optional Feasibility Study (allowing Interconnection Customers to continue to elect the limited Optional Feasibility Study scope provided for in Section 30.6.2(1)); and
 - Provide pending queue projects various options for how they want to move forward (outlined on the following slides).
- **NYISO commenced implementing these rules on 11/30/2023.**
- **NYISO provided notices to Developers concerning the implementation of the interim transition rules, including a FAQ document. Reminder emails have been provided to applicable Developers with instructions regarding required decisions they needed to submit to the NYISO via the Interconnection portal.**
- **On January 25, 2024, FERC issued an order granting the waiver requested in the NYISO's November 3, 2023 filing.**

Interim Transition Rules, cont.

■ Optional Feasibility Study Options for Pending Queue Projects:

- Projects with detailed Optional Feasibility Study scope executed prior to 12/1/2023 had to do one of the following by 12/8/2023:
 - Elect to complete the detailed Optional Feasibility Study;
 - Elect to terminate the detailed Optional Feasibility Study and remain in the queue (subject to transition rules requiring an Interconnection Request in the Transitional Cluster Study);* or
 - Elect to withdraw from the NYISO queue.
- Projects with limited Optional Feasibility Study executed prior to 12/1/2023 had to do one of the following by 12/8/2023:
 - Elect to complete the limited Optional Feasibility Study;
 - Elect to terminate the limited Optional Feasibility Study and remain in the queue (subject to transition rules requiring an Interconnection Request in the Transitional Cluster Study);* or
 - Elect to withdraw from the NYISO queue.

*Default approach if Interconnection Customer failed to timely elect otherwise

Interim Transition Rules, cont.

■ SRIS Options for Pending Queue Projects:

- Projects with OC-approved SRIS scopes prior to 12/1/2023 had to do one of the following by 12/8/2023:
 - Elect to complete the SRIS;
 - Elect to terminate the SRIS and remain in the queue (subject to transition rules requiring an Interconnection Request in the Transitional Cluster Study);* or
 - Elect to withdraw from the NYISO queue.

*Default approach if Interconnection Customer failed to timely elect otherwise

Interim Transition Rules, cont.

■ Additional Transition Rules:

- Projects with validated Interconnection Requests that have timely elected an SRIS or Optional Feasibility Study but do not have an approved scope prior to 12/1/2023 had to do one of the following by 12/8/2023:
 - Elect to proceed with a limited Optional Feasibility Study if one has not yet been performed;
 - Elect to remain in the queue without proceeding to a limited Optional Feasibility Study (subject to transition rules requiring an Interconnection Request in the Transitional Cluster Study);* or
 - Elect to withdraw from the NYISO queue.

*Default approach if Interconnection Customer failed to timely elect otherwise

Interim Transition Rules, cont.

■ Additional Transition Rules:

- Projects with validated Interconnection Requests that have not made election to move to Optional Feasibility Study or SRIS prior to 12/1/2023 had to do one of the following within 5 Business Days of completion of its Scoping Meeting or Optional Feasibility Study:
 - Elect proceed to a limited Optional Feasibility Study if one has not yet been performed;
 - Elect to remain in the queue without proceeding to a limited Optional Feasibility Study (subject to transition rules requiring an Interconnection Request in the Transitional Cluster Study)*; or
 - Elect to withdraw from the NYISO queue.

*Default approach if Interconnection Customer failed to timely elect otherwise

Cluster Study Transition (Post-Compliance Filing Process)

Transition Cluster Study Overview

- **Order No. 2023 provides for a 360-day transition cluster that precedes the initial "standard" Cluster Study.**
 - This would delay the commencement of the new Cluster Study process.
- **NYISO proposes to transition directly into the new Cluster Study process rather than awaiting the end of a year-long transitional study**
 - As depicted on the following slide, the initial Transitional Cluster Study Application Window will allow Interconnection Customers additional time to enter this initial study (105 days vs. 45 days).
 - The validation period will be extended from 10 Business Days to 15 Business Days for the initial Transitional Cluster Study Application Window.
 - In response to Stakeholder feedback, NYISO revised the Compliance Proposal to provide Interconnection Customers with more than a single opportunity for curing deficiencies within the Application Window.
 - The Customer Engagement Window/Physical Infeasibility Screen will also be extended by 20 Calendar Days for purposes of the transitional process (90 Calendar Days vs. 70 Calendar Days).
 - The Transitional Cluster Study will otherwise follow the same process with the same timelines as the "standard" new Cluster Study process.

Transition Overview

- NYISO proposes to immediately implement the new Attachment HH Interconnection Procedures as of April 4, 2024.
- Interconnection Requests submitted after April 4, 2024 will be subject to the new Cluster Study Process.
- The Application Window for the initial Cluster Study – the Transition Cluster Study – will open July 1, 2024.
- During the 3-month window between the effective date of the new Interconnection Procedures and the Transition Cluster Application Window, NYISO start accepting Pre-Application Requests and will be continuing pending studies as further detailed on slides 44-51.
- The proposed schedule for the Transition Cluster Study and commencement of the subsequent Cluster Study are depicted on the following slide.

Transition Process Timeline

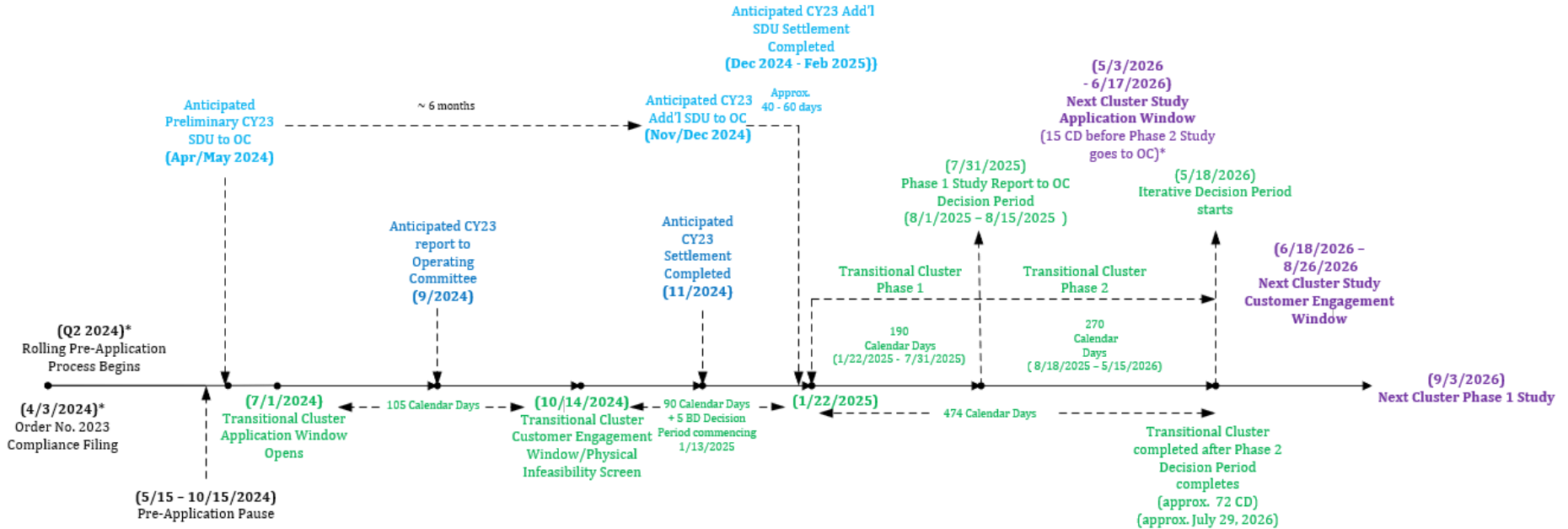

*Proposed Cluster Start Date calculation is 15 CD prior to scheduled OC review of Phase 2 Report

New and Pending Interconnection Requests

- **New Interconnection Requests will continue to be permitted and validated pending the effective date of the compliance filing.**
- **Projects pending in the interconnection queue on the compliance filing effective date** will be withdrawn and not automatically transitioned to the Transitional Cluster Study.
 - To enter the Transitional Cluster Study, pending queue projects must submit a new Interconnection Request in the Application Window and will be assigned a new queue number upon validation in the Transitional Cluster Application Window
 - Deposits required for entry into the Transitional Cluster Application Window will not be offset by the \$10,000 Interconnection Request fee submitted with the project's initial Interconnection Request submitted in the pre-Cluster Study Process.
 - The NYISO will not transfer Study Deposits provided in the pre-Cluster Study Process to satisfy Study Deposit requirements in new process.
 - NYISO will refund any existing Study Deposits subject to reconciliation for incurred study costs.

Pending Interconnection Requests

- **Class Year 2023 projects:**
 - Will proceed under the current Class Year Study process
 - Additional SDU Study completion date (including Security posting) must be 10 BDs prior to Phase 1 start date (vs. ATBA lock down date in subsequent Class Year) Upon the project's acceptance of its Project Cost Allocation for SUFs and posting of Security, the project will proceed to the Interconnection Agreement stage.
 - If the project rejects its Project Cost Allocation for SUFs or has a Security Posting Default:
 - The project can enter the Transitional Cluster Study, as discussed on the following slides.
 - For projects that paid a deposit in lieu of satisfying a regulatory milestone to enter Class Year 2023:
 - Such projects will be eligible for a refund of the \$3,000/MW portion of the deposit upon rejection of Project Cost Allocation for SUFs or a Security Posting Default.
 - \$100,000 portion of the regulatory milestone deposit is refundable only if the regulatory milestone is satisfied by February 13, 2024.
 - CY23 Project will not be withdrawn for failure to satisfy a Regulatory Milestone within 6 months of IA tender.

Pending Interconnection Requests, cont.

- **Class Year 2023 – Contingent Transitional Study Projects:**
 - CY23 will not be completed during the Application Window for the Transitional Cluster Study.
 - A Developer may submit a CY23 project as a contingent project in the Application Window for the Transitional Cluster Study to enable the project to enter the Transitional Cluster Study if it does not accept its Project Cost Allocation in the CY23 decision period.
 - To do so, the projects must satisfy the same application requirements at the Application Window as all other projects, including the non-refundable Application Fee, Study Deposit, and Site Control requirements and must be the same project as the project was proposed in CY23.
 - If the Developer of the contingent project does accept its Project Cost Allocation in the final decision round in CY23, then the contingent project will be removed from the Cluster for the Transitional Cluster Study without a withdrawal penalty.
- **Same rule will apply to projects in Additional SDU Studies in Cluster Study process.**
 - If a project in an Additional SDU Study for Cluster “A” wants to enter a subsequent cluster in the event the Additional SDU Study is not completed prior to 10 BD before Cluster B Phase 1, it must submit an application during the Application Window for Cluster B.

Pending Interconnection Requests, cont.

- **CY2023 – Impact of Contingent Projects on Physical Infeasibility Determinations**
 - As detailed below, NYTOs will perform physical infeasibility screens of projects in the Cluster during the Customer Engagement Window.
 - If one or more contingent projects are seeking access to a limited point of interconnection with other projects in the Transitional Cluster Study, the NYTO will perform two assessments:
 - First assessment:
 - Will assume all the contingent projects accept their Project Cost Allocation and posts Security in CY23 and will assess whether there are physical infeasibility issues for the other Transitional Cluster Study projects.
 - This analysis will be used if the contingent project proceeds in CY23.

Pending Interconnection Requests, cont.

- **CY2023 – Impact of Contingent Projects on Physical Infeasibility Determinations, cont.**
 - Second assessment if one or more contingent projects are seeking access to a limited point of interconnection with other projects in the Transitional Cluster Study:
 - Will assume the contingent projects do not accept its Project Cost Allocation and posts Security in CY23.
 - This analysis will be used if the contingent project does not proceed in CY23.
 - In such case, the NYTO will assess the physical infeasibility of all Transitional Cluster Study projects, including the contingent project, based on their priority in the Transitional Cluster Study.
 - That is, a contingent project does not have priority due to its participation in CY23; its priority will be determined, as with all other projects, on its date/time for submitting its Interconnection Request in Application Window.

Additional SDU Study for Transitional Cluster

Additional SDU Study

■ For Transition Cluster

- Proceed as normal and terminate the Additional SDU Study if it hasn't completed within 10 BD prior to the Transition Cluster Phase 1 Start Date
- If Additional SDU Study is terminated, the IC may submit an Interconnection Request or CRIS-Only Request in Application Window of subsequent Cluster Study Process

■ Going forward Clusters

- **Determined to Retain Additional SDU Study for new Byways as well as Highways and Other Interface SDUs.**
- See tariff revisions to Section 40.14
- **Clarified the impacts of terminated Additional SDU Studies on Contingent Projects and Withdrawal Penalties**

■ Decision Period

- Interconnection Customer in an Additional SDU Study cannot defer its ERIS decision (acceptance/rejection of SUF costs) until the Additional SDU Study Decision Period – it must make a decision in the Final Decision Period at the conclusion of the Phase 2 Study

Treatment of Pending Attachment S, Attachment X and Attachment Z Studies

Treatment of Pending Attachment S, X and Z Studies

- **Attachment S Studies: Class Year Study and Expedited Deliverability Study**
 - No change to the NYISO's proposal regarding the treatment of the Class Year 2023 Study
 - **Expedited Deliverability Study**
 - EDS 2023-01 completed February 26, 2024
 - The start date for EDS 2024-01 is March 28, 2024
 - Since the next EDS (EDS 2024-01) commences prior to the effective date of the new Attachment HH, Small Gen projects that may enter under the existing rules (with only a Small Gen SIS) will be withdrawn from the EDS 2024-01 after the effective date of the new Attachment HH if they don't have a completed Small Gen Facilities Study **or is not commencing or continuing a Small Gen Facilities Study pursuant to the transition rules.**

Treatment of Pending Attachment S, X and Z Studies

- **Attachment X and Z Studies: FES, SIS, SRIS and Small Gen Facilities Study:**
 - Continue pending studies through end of Application Window using Reasonable Efforts subject to the transition rules described on the following slide
 - Study deemed “pending” as of the effective date of the new Attachment HH if (1) it has satisfied all requirements for commencement of the applicable study (including confirmation of required technical data) and (2) the final short circuit cases have been completed and provided to the Connecting/Affected Transmission Owner(s)

Treatment of Pending Attachment S, X and Z Studies

- **Attachment X and Z Studies: FES, SIS, SRIS and Small Gen Facilities Study. cont:**
 - Pending FES, SIS or SRIS
 - Projects subject to an ongoing FES, SIS, or SRIS cannot enter the Transition Cluster Study unless the ongoing study is completed or terminated. Developer may cure this deficiency by requesting NYISO terminate study.
 - Studies are for informational purposes only
 - Small Gen Facilities Studies terminate at the end of the Application Window (these projects can enter the Application Window as a Continent Project)
 - In determining whether to proceed with pending studies, developers should consider that while they will be performed using Reasonable Efforts, there is no guarantee these studies will be completed prior to the cutoff dates described above

Pre-Application Process

Pre-Application Process

- **NYISO proposes to include in its compliance filing a Pre-Application process to further the goal of Order No. 2023 to provide greater information access to potential Interconnection Customers.**
- **Proposed optional Pre-Application Process would be available to prospective:**
 - Small Generating Facilities;
 - Large Generating Facilities; and
 - Transmission projects subject to the Large Facility Interconnection Procedures (currently defined as “Class Year Transmission Projects”)

Pre-Application Process

- **Any requester (whether in the interconnection queue or not) can submit a request using the Pre-Application Request form.**
 - \$5,000 per Point of Interconnection
 - 25% allocated to NYISO
 - 75% allocated to Connecting TO/Affected TOs
 - Maximum of 2 POIs per Pre-Application Request
 - Pre-Application Requests can be submitted on a rolling basis at any time except during the following 90-day timeframe:
 - 45-calendar days before a Cluster Application Window begins through the end of the Application Window
 - This pause will enable the NYISO/NYTOs to focus on completing pending Pre-Application Requests and timely validating Interconnection Requests in the Application Window.
 - Pre-Application Request form is posted with the meeting materials

Pre-Application Process, cont.

- **NYISO will route the Pre-Application Request to the applicable Connecting Transmission Owner and Affected Transmission Owner (ATO for local SUFs only)**
 - Upon the Transmission Owner confirmation that it is the Connecting Transmission Owner, it will proceed to a scoping meeting
 - Connecting Transmission Owner will complete the Pre-Application Report within 25 Business Days after the Pre-Application scoping meeting.
- **Information available in a Pre-Application Report* (see template posted with meeting materials):**
 - POI line/substation name, ID, bus numbers and circuit IDs, voltage, ratings (normal, LTE and STE), terminal end stations
 - For sub-transmission and distribution POIs, circuit loading, peak and minimum load, existing generation MW and proposed generation MW
 - Additional Information (e.g., description of potential new substation bus configuration (not a conceptual one-line diagram), transmission constraints, planned transmission upgrades, parallel lines, breaker rating, available breaker positions, existing/known constraints known physical feasibility issues)

*To the extent readily available data exists

Application Window

Application Window - Overview

- **Interconnection Requests permitted anytime during the 45-day Application Window (105-day window for the Transition Cluster Study Process)**
- **Single POI per Interconnection Request unless:**
 - Project is a Class Year Transmission Project
 - Project is a Generating Facility interconnecting via two kV levels in the same Capacity Region
- **Projects that are alternatives cannot be evaluated in the same Cluster Study**
- **CRIS-only projects must submit a CRIS-Only Request during the Application Window but will have a lower application fee (\$5,000) and study deposit (\$50,000).**

Interconnection Request Requirements

1. Non-refundable application fee \$10,000 (cash only) (\$5,000 for CRIS-only projects):
75% allocated to NYISO and 25% Connecting TO/Affected TOs
2. Study Deposit (cash or Letter of Credit):

Size of Proposed Generating Facility Associated with Interconnection Request	Amount of Deposit
< 80 MW	\$100,000
≥ 80 MW < 200 MW	\$150,000
≥ 200 MW	\$250,000

Study Deposit for CRIS-only projects is \$50,000.

Interconnection Request Requirements, cont.

3. Conceptual one-line diagram that includes:

- The Project name, and the Interconnection Customer name on the diagram;
- The facility address (specific location – coordinates or closest street address);
- The number of inverters or generator units (type, nameplate rating MW and MVA), and configuration of the facility;
- The facility's electrical components (*i.e.*, generation, transformers (GSU, PSU, current transformer, and potential transformers), breakers, switches, cables/lines/feeders, compensation, FACTs, auxiliary load, buses, etc.) as described in the modeling data form;
- The capability and voltage levels of the electrical components, their connection to each other and to the New York State Transmission System or Distribution System;
- The Point of Interconnection (name of the substation name (specify the bus) or transmission/distribution line name and number);
- References to other diagram sheets if there is more than one diagram sheet (*i.e.*, use references to indicate how the diagrams are interconnected).
- Acronyms used in the conceptual breaker one-line diagram should follow ANSI Standard Device Numbers & Common Acronyms.

Interconnection Request Requirements, cont.

4. **Completed Interconnection Request must also include a project layout that shows general project layout and location of project in relation to proposed POI, including specific POI**
 - Must indicate voltage level, address, coordinates, location in relation to facility
 - Interconnection Customer does not need to specify breaker position in a substation
5. **Workable individual project models (*e.g.*, short circuit, steady-state, and stability)**
6. **Attestations (for Generating Facilities greater than 20 MW) required by the final, approved NYSRC Reliability Rule B.5 (currently PRR 151) establishing minimum interconnection standards for Inverter Based Resource (IBR) Generating Facilities based on IEEE Standard 2800-2022**

Interconnection Request Requirements, cont.

8. Demonstration of Site Control

9. Connecting Transmission Owner/Affected Transmission Owner-specific data for purposes of Phase 1 Study

Cluster Study Agreement

- NYISO will circulate an executable version of the Cluster Study Agreement to the Interconnection Customer, Connecting Transmission Owner, and any identified Affected Transmission Owner(s)/Affected System Operator(s) as soon as practicable after validating the Interconnection Request/ CRIS-Only Request in the Application Window.
 - If the validation occurs in the Customer Engagement Window, the NYISO will provide the executable version of the agreement within 10 Business Days of execution.
- The parties to the agreement must then execute the agreement within 10 Calendar Days.
- If the NYISO subsequently identifies additional or other Connecting Transmission Owner(s), Affected Transmission Owner(s), or Affected System Owner(s), the parties will amend the agreement to include these parties.
- NYISO also amended Interconnection Request/ CRIS-Only Request form for officer/ authorized person for Interconnection Customer to attest with the submission of the request form that its submission is accurate and complete, the it acknowledges that it will be required to execute the Cluster Study Agreement, and that it acknowledges and agrees to be responsible for its study costs, including study costs incurred prior to the full execution of the Cluster Study Agreement.

Interconnection Request - Validation

- Validation on a rolling basis for Interconnection Requests submitted during window
- **Within 10 Business Days*** of receipt of Interconnection Request
 - NYISO reviews Interconnection Request to identify the Connecting TO and Affected TOs
 - NYISO notifies Connecting TO and Affected TOs it is aware of via Interconnection Portal
 - Connecting TO confirms (via portal) it is the Connecting TO and confirms Affected TOs
 - NYISO confirms receipt of payment of application fee and study deposit
 - NYISO acknowledges receipt of the facility model
 - Interconnection Customer must address any deficiencies with the models prior to the Scoping Meeting in the Customer Engagement Window
 - NYISO notifies Interconnection Customer that Interconnection Request is valid or identify deficiencies
- *** 15 Business Days for validation for the Transitional Cluster Study to account for administering new process and to address potentially significant number of Interconnection Requests**

Interconnection Request - Deficiencies

- An Interconnection Customer must cure Interconnection Request deficiencies within 10 Business Days (15 Business Days for Transition Application Window) of its receipt of a deficiency notice from the NYISO, but no later than the end of the Application Window.
- Interconnection Requests submitted with less than 10 Business Days prior to the end of the Application Window may not have the opportunity to cure deficiencies. (NYISO is afforded 10 Business Days to validate Interconnection Requests.) This period will be 15 Business Days for the Transition Cluster Study.
- Interconnection Customer can continue to cure deficiencies throughout the duration of the Application Window.
- Cure process will not be an iterative process; NYISO will identify deficiencies in its first review of the application and Interconnection Customer must address all deficiencies with each cure response submittal. NYISO will not separately validate each submission for individual deficiencies.
- Notwithstanding this validation, the Interconnection Customer must also satisfy the requirements for submitting and addressing any deficiencies for the Facility model and any Transmission Owner specific technical information.

Interconnection Request – Deficiencies, cont'd

- Interconnection Customers will have 10 Business Days to cure identified deficiencies (15 Business Days for the Transition Cluster).
- NYISO will review the submitted information to cure the identified deficiencies within 10 Business Days (15 Business Days for the Transition Cluster) and notify the Interconnection Customer of any additional deficiencies.
- This process will continue until the close of the Application Window (*i.e.*, Interconnection Customer may have more than one cure opportunity, depending on the timing within the Application Window).
- **NYISO will continue its validation process in the start of the Customer Engagement Window for applications submitted late in the Application Window.**
- Interconnection Customers must satisfy subsequent requests for additional information needed to address incomplete data, errors, or additional information required for the ISO's or Transmission Owners' performance of their responsibilities in Attachment HH within 10 Business Days.

Interconnection Request – Site Control

- **Demonstration of full Site Control for Facility (Generating Facility or Cluster Study Transmission Project) with Interconnection Request**
 - Site Control for at least 10 years of expected operation of the Generating Facility
 - Re-confirmation of full Site Control with project modifications or COD extensions
 - Developer not required to demonstrate Site Control for generator tie line or POI facilities
- **Elimination of the option to post a deposit in lieu of Site Control unless the Interconnection Customer can demonstrate a "regulatory limitation" making it practically infeasible to obtain Site Control within the required time frame (discussed in more detail on slides 70-71).**
- **For co-located generating facilities on the same site and behind the same Point of Interconnection, the Interconnection Customer must demonstrate via contract or other agreement shared land use for all co-located generating facilities that meet the Site Control definition.**
- **Interconnection Customer cannot submit the same land for multiple Interconnection Requests, unless the site is large enough to host multiple generating facilities.**
- **NYISO modified timeframe for developer to address a material change in Site Control from 10 to 15 Business Days.**

Interconnection Request– Site Control

General Submission Requirements

- **Interconnection Customer must provide documentation that demonstrates Interconnection Customer has the rights to develop specific fuel source and clearly sets forth the acreage.**
- **The party's name listed on the documentation to demonstrate site control should match the name of the Interconnection Customer on record with the NYISO.**
 - **In situations where the name differs, the Interconnection Customer is responsible for providing additional documentation explaining the corporate relationship such as, an SEC filing, document on file with the applicable secretary of state, other official corporate document, or a purchase sale agreement.**
- **If the same Site Control is being used for facilities under different Interconnection Requests, Interconnection Customers must also explain how all proposed facilities will be situated within the area (mutually exclusive alternatives are not permitted)**
- **Interconnection Customer must provide detailed site plan and equipment layout detailing the conceptual design of the proposed facility and how it is situated within the area that is covered by the Site Control and available for the Interconnection Customer's use. Include any wetlands, unusable land, spacing, setbacks, etc.**

Interconnection Request– Site Control

■ Document Requirements

- A legally binding instrument, fully executed, that demonstrates the following:
 - The Interconnection Customer has the right to develop specific fuel source
 - Statement of exclusivity
 - Permission to use the site
 - Clearly identifies acreage of parcel
 - Term of at least 10 years
- Accepted documents:
 - Title, Deed, or Tax Bill
 - Lease Agreement (includes BOEM lease for offshore wind projects)
 - Option to Lease or Option to Purchase (underlying Lease must be for a term of at least 10 years, not a 10-year option)
 - Easement
 - Right of Way
- If document is not from the NYISO's accepted listed, language in the document must demonstrate Interconnection Customer has the rights described above.

Interconnection Request– Site Control

Document Requirements cont.

- All Interconnection Customers must submit the following for site control:
 - Legally binding instrument from the “Accepted Documents” list
 - A signed attestation indicating:
 - the amount of acreage covered by the site control materials provided by the Interconnection Customer; and
 - One of the following representations:
 - The acreage meets the minimum requirements listed in the Technology Acreage Requirements Table; or
 - The acreage does not meet the minimum requirements listed in the Technology Acreage Requirements Table and the interconnection customer will satisfy the additional requirements for projects that do not meet minimum acreage requirements
 - Site Plan Map that depicts:
 - Project Boundaries
 - Boundaries of Parcel(s) and/or total lease area
 - POI
 - Proposed Tie-Line and Collector Routes
 - Interconnection Facilities
 - Any known site limitations such as wetlands, unusable land, spacing, setbacks, etc.

Interconnection Request – Site Control

- **Interconnection Customer must demonstrate the exclusive land right to develop, construct, operate, and maintain its generating facility or, where facilities are co-located, to demonstrate a shared land use right to develop, construct, operate, and maintain co-located facilities.**
 - In Order No. 2023 (P 585), FERC clarified that “the right to ‘exclusively’ occupy the site to develop, construct, operate, or maintain a generating facility means both that the right belongs solely to the interconnection customer (no other entity shares the right to use the site for those purposes), as well as that the right is solely for purposes of a single interconnection request.”
 - FERC further clarified in paragraph 587 that the term “exclusive land rights” in the definition of site control “applies only to the exclusivity required to develop, construct, operate, and maintain the interconnection customer’s proposed generating facility,” and that the term “exclusive land rights” does not restrict multi-use applications of the site in addition to its use for the generating facility, such as agriculture, ranching, etc.

Interconnection Request – Site Control

- Proposed definition (consistent with *pro forma* definition in Order No. 2023 with certain NYISO edits) revises the existing Site Control definition in NYISO’s interconnection procedures as follows:

Site Control shall mean the necessary land right sufficient to develop, construct, operate, and maintain the Facility over a term of at least 10 years, Site Control may be demonstrated by documentation establishing: (1) ownership of, a leasehold interest in, or a right to develop a site of sufficient size to construct and operate the Facility; (2) an option to purchase or acquire a leasehold site of sufficient size to construct and operate the Facility; or (3) any other documentation that clearly demonstrates the right of Interconnection Customer to occupy a site of sufficient size to construct and operate the Facility. The term “necessary land right” restricts the use of the site for mutually exclusive projects, but does not restrict multi-use applications of the site in addition to its use for the Facility, such as agriculture, ranching, etc. The ISO will maintain acreage and other applicable parameters for each facility type on its OASIS or public website.

Interconnection Request – Site Control, cont.

- **An Interconnection Customer with a demonstrated regulatory limitation, including those associated with obtaining a lease on Tribal lands, may submit a deposit in lieu of Site Control.**
 - To demonstrate regulatory limitations, Interconnection Customer must submit:
 - 1) a signed affidavit from an officer of the company indicating that Site Control is unobtainable due to regulatory limitations as the term is defined by the NYISO; and
 - 2) documentation sufficiently describing and explaining the source and effects of such regulatory limitations, including a description of any condition that must be met to satisfy the regulatory limitations and the anticipated time by which the Interconnection Customer expects to satisfy the regulatory restrictions.
 - Order allows Transmission Providers to develop the specific definition for “regulatory limitations” and to update definition over time as relevant federal, state or local laws change.
 - NYISO is considering comments on potential regulatory limitations

Interconnection Request – Site Control, cont.

- **Deposit in lieu of Site Control for an interconnection customer with a demonstrated regulatory limitation**
 - \$10,000 per MW, subject to a floor of \$500,000 and a ceiling of \$2 million, as established in Order No, 2023.
 - Deposit must be submitted at the same time as submission of the Interconnection Request.
 - Deposit will be held by the NYISO until the Interconnection Customer can demonstrate 100% Site Control prior to entering the Cluster Study Phase 2, unless Interconnection Customer provides documentation that demonstrates they are taking identifiable steps to secure the necessary regulatory approvals.
 - Such Interconnection Customer must demonstrate 100% Site Control within 180 calendar days of the effective date of the LGIA. Otherwise, the LGIA may be terminated, and the Interconnection Customer could be subject to forfeiting its security.
 - The deposit is refundable but cannot be applied toward interconnection studies or withdrawal penalties.

Site Control - Regulatory Limitations

- NYISO proposes to define a regulatory limitation as “a federal, state, Tribal, or local law, other than permitting and siting requirements, that makes it infeasible to obtain Site Control prior to an Interconnection Customer's submission of the Interconnection Request as set forth in ISO procedures.”
- A regulatory limitation is not intended to include permitting or siting issues.
- An example of a regulatory limitation
 - Projects experiencing delays in obtaining exclusive land rights for site control on Tribal lands
- Examples of what is not considered a regulatory limitation
 - The BOEM-administered auction
 - Moratoriums (local or regional) on development of certain technology projects – while a moratorium prevents a developer from obtaining zoning approvals for a project, it does not prevent a developer from obtaining land rights

Interconnection Request– Site Control, cont.

■ Technology-specific Acreage Requirements

- Interconnection Customer must demonstrate that the area covered by the Site Control can reasonably accommodate the development of the proposed generating facility based on the identified technology and equipment in the Interconnection Request and any known limitations with the parcel (e.g., wetlands or exclusions to the Interconnection Customer’s right to develop the property).
- Per Order No. 2023, Transmission Providers have flexibility to establish appropriate technology-specific acreage requirements for generating facilities but must publicly post the requirement.
- Currently, the NYISO uses general acreage guidelines as a starting point, but considers the information submitted by the Interconnection Customer based on the specifics of the facility or proposed technology.

Interconnection Request – Site Control, cont.

- Preliminary technology-specific acreage requirements (to discuss further IITF meeting(s)):

Technology Type	Acres/MW
Solar	<ul style="list-style-type: none">• 2.8 acres/MWdc for fixed tilt PV plants• 4.2 acres/MWdc for tracking plants
Wind (Land Based)	15 acres/MWac
Offshore Wind	50 acres/MWac
Battery Energy Storage	0.01 acre/MWhac
Other	Submit a scaled site plan detailing the conceptual design of the proposed facility and how it is to be situated within the area that is covered by the Site Control.

- ***Acreage and other applicable Site Control parameters, including guidance for Site Control for Cluster Study Transmission Projects, will be included in NYISO manual; Developers will have the opportunity to review and comment on requirements as part of the manual update process.**
- See following slide for Site Control requirements for projects that do not satisfy acreage requirements.

Interconnection Request– Site Control, cont.

- Additional Requirements for Projects that Do Not Meet the Minimum Acreage Requirements:
 - Must submit, with the Interconnection Request, a detailed narrative that explains why the site can accommodate the Generating Facility on land that is below the minimum acreage
 - Must submit, with the Interconnection Request, a Site plan and equipment layout (including any limitations on the site - wetlands, unusable land, spacing, setbacks, etc.) **signed and stamped** by a licensed Professional Engineer (PE)

Interconnection Request - IEEE 2800 PRR 151 Attestation

- On February 9, 2024, the New York State Reliability Council approved Proposed Reliability Rule (PRR) 151, which adopted a new Reliability Rule B.5 ([RR-#151-2-12-2024.pdf\(nysrc.org\)](#)) and associated Procedure for Application Document ([RR #151 Procedure Document 2-11-2024](#)).
- As required by Reliability Rule B.5, the NYISO will require that an officer for each Facility constituting an Inverter-based Resource (IBR) of greater than 20 MW, after conducting due diligence, complete a form attesting to the following two statements at the time of submitting an Interconnection Request:
 - The proposed Facility will be designed to be in compliance with the mandatory requirements of IEEE 2800-2022, as amended by "NYSRC Procedure for Application of IEEE 2800-2022 Standard for Large IBR Generating Facilities for the New York Control Area," and
 - The models and data provided for the proposed Facility for use in NYISO's Interconnection Studies accurately simulates the performance of their compliant IBR plant.
- This attestation will be mandatory for all Interconnection Requests for facilities seeking to participate in the Transition Cluster Study and all subsequent Cluster Studies.
- If an Interconnection Customer is unable or unwilling to complete this Attestation, they are advised to contact the New York State Reliability Council (NYSRC) to request an Exception to Reliability Rule B.5.
- The NYISO will not accept an Interconnection Request for an IBR greater than 20 MW in the absence of a completed Rule B.5 Attestation or an Exception to Rule B.5 granted by the NYSRC.
- **NYISO posted the attestation form with the March 15th IITF materials.**

Study Deposits and Commercial Readiness Requirements

Study Deposits/Fees

- **Non-refundable Application Fee submitted with Interconnection Request during the Application Window: \$10,000 (in cash) plus a one-time Study Deposit based on size of project submitted with Interconnection Request:**

Size of Proposed Generating Facility Associated with Interconnection Request	Amount of Deposit
< 80 MW	\$100,000
≥ 80 MW < 200 MW	\$150,000
≥ 200 MW	\$250,000

- **Study Deposits and Commercial Readiness Deposits can be submitted as cash or through a Letter of Credit**
 - Att HH will detail cash and Letter of Credit deposit requirements.
- **Application Fee and Study Deposit is in addition to the Commercial Readiness Deposits detailed on slide 67.**
- **If Small Generating Facilities are included in Cluster Study Process, the Study Deposit for these facilities is \$100,000.**
- **For CRIS-only projects, the one-time Study Deposit is \$50,000.**

Study Deposits/Fees cont'd.

- **The NYISO will invoice Interconnection Customers actual study costs on a monthly basis.**
 - Failure to timely pay a monthly invoice will result in withdrawal of the project from the interconnection queue
 - NYISO may use the study deposit to cover any invoiced but unpaid study costs.
- **Applicable Study Deposit and Commercial Readiness Deposit will remain in place for duration of the Cluster Study Process and will be subject to withdrawal penalties as described in slides 94-99.**
- **If, at the completion of Phase 2 of the Cluster Study Process, Interconnection Customer accepts its cost allocation and posts security, the NYISO will refund the full amount of both the Study Deposit and Commercial Readiness Deposit (after final invoicing and payment of study costs).**

Transition Cluster Fees/Deposits

- All Interconnection Customers electing to participate in the Transition Cluster Study must submit the \$10,000 non-refundable application fee with its Interconnection Request submittal during the Application Window along with the applicable Study Deposit.
- NYISO will not require the \$5M transition fee, as described in Order No. 2023.

Commercial Readiness Deposits

To enter Phase 1 (Readiness Deposit 1) Due during Decision Period 1	\$4,000/MW
To enter Phase 2 (Readiness Deposit 2) Due during Decision Period 2	The greater of (i) Readiness Deposit 1, and (ii) 20% of cost estimate determined in Phase 1 (Phase 1 cost estimates include: Local SUF and CTOAF)
At conclusion of Phase 2 in Decision Period (pay cash and/or security)	100% of costs estimate of SUFs, SDUs, and CTOAFs identified in Phase 1 and Phase 2

- No Regulatory Milestone requirement
- Commercial Readiness Deposits are cumulative, not additive (Application Fee and Study Deposits not considered in calculating the applicable cumulative amount).
- Generating Facilities 20 MW or smaller are included in Cluster Study Process and will have to satisfy these requirements.
- Commercial Readiness deposits will not be required for CRIS-only projects, but such projects must pay the Security payment at the end of Phase 2 upon acceptance of its Project Cost Allocation, if any.

Total Fees and Deposits

<p>To submit an Interconnection Request</p>	<p>\$10,000 non-refundable fee <u>plus</u> study deposit:</p> <table border="1" data-bbox="1052 253 1684 464"> <thead> <tr> <th>Size of Proposed Generating Facility Associated with Interconnection Request</th> <th>Amount of Deposit</th> </tr> </thead> <tbody> <tr> <td>< 80 MW</td> <td>\$100,000</td> </tr> <tr> <td>≥ 80 MW < 200 MW</td> <td>\$150,000</td> </tr> <tr> <td>≥ 200 MW</td> <td>\$250,000</td> </tr> </tbody> </table>	Size of Proposed Generating Facility Associated with Interconnection Request	Amount of Deposit	< 80 MW	\$100,000	≥ 80 MW < 200 MW	\$150,000	≥ 200 MW	\$250,000
Size of Proposed Generating Facility Associated with Interconnection Request	Amount of Deposit								
< 80 MW	\$100,000								
≥ 80 MW < 200 MW	\$150,000								
≥ 200 MW	\$250,000								
<p>To enter Phase 1 (Readiness Deposit 1)</p>	<p>\$4,000/MW (not applicable for CRIS-only projects)</p>								
<p>To enter Phase 2 (Readiness Deposit 1)</p>	<p>The greater of (i) Readiness Deposit 1, and (ii) 20% of cost estimate determined in the Phase 1 study (cost estimates include: Local SUF and CTOAF) (not applicable for CRIS-only projects)</p>								
<p>At conclusion of Phase 2 in Decision Period (pay cash and/or security)</p>	<p>100% of costs estimate of SUFs, SDUs, and CTOAFs identified in Phase 1 and Phase 2 (not applicable for CRIS-only projects)</p>								

Customer Engagement Window

Customer Engagement Window

- Commences immediately after completion of the Application Window; engagement window will be a 70-Calendar Day period (90 Calendar Days for Transition Cluster Study).
- NYISO will publish the list of the projects in the cluster with associated priority
 - List is publicly posted within 10 Business Days after commencement of the Customer Engagement Window
 - Priority within the Cluster is assigned based on Interconnection Request submission date/time in Application Window
 - Project may withdraw without penalty within 5 Business Days after publication of list.
- **Physical Infeasibility Screen**
 - Performed by the Connecting TO and Affected TOs
- **NYISO coordinates a Clustered Scoping Meeting for all projects in the Cluster Study**
 - Discuss the study scope, schedule, and work plan
 - Discuss results of the physical infeasibility screen
 - Alert Interconnection Customers to potential physical infeasibility issues

Customer Engagement Window - Physical Infeasibility Screen

- **A project deemed physically infeasible will not be permitted to proceed to the next Cluster Study phase.**
 - If physical infeasibility is identified in Customer Engagement Window's preliminary physical infeasibility screen, the project cannot proceed to Cluster Study Phase 1.
 - If physical infeasibility is identified in Cluster Study Phase 1, the project cannot proceed to Cluster Study Phase 2.
 - If physical infeasibility is identified in Cluster Study Phase 2, the project cannot proceed to the Cluster Study Phase 2 decision phase.
- **See following slide for proposed definition of physical infeasibility**

Customer Engagement Window - Physical Infeasibility Screen

- A project may be deemed physically infeasible if:
 - 1) the substation for the selected Point of Interconnection (POI) does not have any available bus positions and
 - a) is not expandable electrically or within the existing substation footprint, or
 - b) adjacent usable vacant land is not available, or
 - c) proposals by Interconnection Customer are inconsistent with Good Utility Practice or Applicable Reliability Standards; or
 - 2) A viable tie line cable route cannot be established from either the Point of Change of Ownership to the Point of Interconnection or, where those points are the same, a viable route within or from the fence line; or

Customer Engagement Window

- Physical Infeasibility Screen Definition, cont.

- 3) The project capacity exceeds the ratings of equipment at the substation selected for the POI and replacement equipment that would be adequately rated for the project capacity is not commercially available from an approved supplier and within applicable specifications set by the Transmission Owner, and an alternative upgrade is not physically feasible (e.g., higher voltage POI substation).
 - Acceptable commercially available equipment is equipment manufactured by an approved supplier of a particular CTO and conforming with engineering specifications and procedures of the CTO.

Prioritization for Infeasibility Issues

- As a general matter, projects participating in a Cluster Study will not have priority over other projects participating in the same study based on queue number.
- Priority rules will only be triggered in the event of certain physical infeasibility determinations that result in a “jump ball” between two similarly situated projects for access to limited points of interconnection.
- Priority within the Cluster is assigned based on Interconnection Request submission date/time in Application Window.

Modifications

Project Modifications

- **Modifications during Cluster Study Process only permitted in limited instances**
 - Interconnection Customers may propose a POI modification (not modifications to electrical parameters) within 5 Business Days after the NYISO posts the Cluster list in the Customer Engagement Window.
 - Contingent Projects may not change their POI during this time period. If a Contingent Projects has withdrawn from its ongoing study or that study is completed prior to this 5 BD period, such project may propose a POI modification during this period.
 - Consequence of such modification during the Customer Engagement Window is a drop in the project's priority within the Cluster.
 - As with current Class Year process rules, Interconnection Customers cannot make other modifications within Cluster Study Process.
 - Once base case is locked down, even minor modifications require base case updates and can delay the study process.
 - They can propose such modifications for NYISO materiality review following the Phase 2 decision period at the completion of the Cluster Study Process.
 - Interconnection Customer may withdraw from the Application Window and resubmit a modified project in that Application Window or in a subsequent Cluster Study Application Window, subject to the timing and submission requirements for a new Interconnection Request.

COD Extensions and Demonstrations of Reasonable Progress

COD Extensions

■ COD extensions:

- Current rule allows a project's COD to be extended up to 4 years from completion of Class Year Study. Further extensions require demonstration of reasonable progress against project milestones in the IA.
- NYISO does not propose a different COD extension period, but does propose to revise the criteria for demonstrating reasonable progress:
 - Reasonable progress need not be tied to milestones in the Interconnection Agreement
 - COD extension can be requested prior to executing an Interconnection Agreement
- NYISO has concerns about allowing longer extensions in the absence of restudies/adjustments to secured cost estimates and therefore proposes the limitations set forth on the following slide.
- NYISO is considering comments on suggested project development milestones that demonstrate Reasonable Progress. More detailed examples will be provided at future IITF(s).

COD Extensions and Demonstrations of Reasonable Progress

- Extension of CODs beyond the 4-years post-Cluster Study completion will be permitted only if the following conditions are satisfied:
 - Demonstration of either (1) technology-specific reasons or reasons beyond the Interconnection Customer's control or (2) reasonable progress notwithstanding the delay (detailed further on the following slide);
 - Schedule agreed upon by the CTO that demonstrates that its project would meet the extended COD;
 - Confirmation by the NYISO (per standard modification review criteria) that extending the COD would not have a material adverse impact on other projects that may be relying on the project's upgrades; and
 - Confirmation by the NYISO and CTO that cost estimate update is not required or if required, that a cost estimate update is completed and Interconnection Customer agrees to and posts security for increases in cost estimates for SUFs, SDUs and CTO AFs.
 - The need and timeframe for any cost estimate update will be made at the time the COD extension request is made and considering the requested time frame.
 - TO can perform limited study as part of cost estimate update to identify replacement equipment if the equipment identified in the applicable interconnection study is no longer available.

COD Extensions and Demonstrations of Reasonable Progress

- NYISO proposes to allow COD extensions required due to technology-specific reasons or reasons beyond the Interconnection Customer's control upon demonstration (via an Officer certification):
 - that its Facility cannot meet the timeframe due to its technology type or due to the sequencing of work on the transmission or distribution system that is beyond its control (e.g., unavailability of required system outages) and
 - that its project is still progressing to the extent possible
- NYISO proposes that Reasonable Progress may be demonstrated (via an Officer certification) of the following:
 - that it has made reasonable progress in the development of its project against milestones set forth in the Interconnection Agreement or in the milestone schedule that it has agreed upon with the Connecting Transmission Owner that meets the requested extended Commercial Operation Date
 - that it has met a critical milestones (e.g., its completion of engineering design, major equipment orders, or commencement and continuation of construction of the Facility and associated upgrades)
- **NYISO inserted “completion of applicable permitting process” as an additional critical milestone that can demonstrate reasonable progress.**

Withdrawal Penalties

Withdrawal Penalties

- If a project withdraws during the Application Window or up to within 5 Business Days of the NYISO publishing the cluster member list in the Customer Engagement Window, there is no withdrawal penalty.
- Withdrawal Penalty 1 - If a project withdraws during the Customer Engagement Window or at the Decision Point to Enter Phase 1, it forfeits 25% of its Study Deposit.
- Withdrawal Penalty 2 - If a project withdraws during Phase 1 or at the Decision Point at the conclusion of Phase 1, it forfeits an amount equal to 50% of the Study Deposit and 10% of the Readiness Deposit 1.
- Withdrawal Penalty 3 - If a project withdraws during Phase 2 or at the Decision Point at the conclusion of Phase 2, it forfeits an amount equal to 100% of the Study Deposit and 20% of the Readiness Deposit 2.
- Security Forfeiture - If a project accepts its project cost allocation and pays cash or posts Security, and later withdraws, it may forfeit up to 100% of this deposit if other projects are relying on the CTOAFs or upgrades.

Withdrawal Penalties

- Any withdrawal penalties are in addition to any outstanding amounts owed for study costs. The NYISO may use the cash deposit or letter of credit to cover any outstanding study costs and applicable withdrawal penalties.
- Withdrawals for physical infeasibility issues will not be subject to penalty.

Withdrawal Penalties

- **Reduce penalty amount for increases in upgrades costs:**
 - Only applicable at end of Phase 2 (for increases to Phase 1 cost estimates)
 - Reductions:
 - Applies if cost increase is greater than 50% (i.e., the final cost allocation at end of Phase 1 vs. total non-SDU cost allocation that Interconnection Customer rejects at end of Phase 2). **Costs concerning required upgrades for Affected Systems in New York are captured in the cost estimates, but not cost estimates for upgrades for neighboring systems.**
 - Reduces Withdrawal Penalty 3 amount to 100% of the Study Deposit (vs. 100% of the Study Deposit plus 20% of the Readiness Deposit 2)

Withdrawal Penalties

■ Allocation of Withdrawal Penalties

- Any withdrawal penalties will first be used to offset the study costs of the remaining projects in the cluster that have accepted their cost allocation and posted security, including for CRIS-only Cluster Study Projects that accepted their cost allocation and posted security.
- If penalty costs have been collected greater than actual study costs amounts for a given cluster, this amount will be allocated to projects in the withdrawing project's cluster upon their commercial operation on a pro rata basis to incentivize projects to proceed to commercial operation.
 - Pro rata amount established at completion of Phase 2 Decision Period
 - Funds will be paid out to a particular Interconnection Customer upon its achievement of Commercial Operation
 - Funds allocated to an Interconnection Customer that later withdraws before Commercial Operation will be forfeited and used to offset NYISO interconnection administrative costs

Withdrawal Penalties

■ Allocation of Withdrawal Penalties – Example

- Assume 10 projects have accepted their Project Cost Allocation and posted the related Security at the conclusion of Phase 2 of a Cluster Study.
 - 1) The NYISO will first use the collected withdrawal penalty amounts for that Cluster Study to offset the study costs incurred by the remaining 10 projects in the Cluster Study.
 - 2) After Step 1, assume that there is \$1,000,000 remaining.
 - The NYISO will divide the \$1,000,000 by the 10 projects to determine a \$100,000 amount for which each project is eligible if it enters into Commercial Operation.
 - Upon the project's entering into Commercial Operation, the NYISO will distribute the \$100,000 to the Interconnection Customer.
 - If the project withdraws, that \$100,000 will instead be forfeited and used by the NYISO to offset its interconnection administrative costs.

Phase 1 Study

Phase 1 Study

- **Comparable to Class Year Part 1 Study**
- **Will provide Interconnection Customers with Project Cost Estimate for Local SUFs, CTOAFs, and Distribution Upgrades**
 - Local SUFs, CTOAFs, and Distribution Upgrades subject to change in Phase 2 based on rejections in Phase 1 decision period.
- **To proceed to the Phase 2 Study, the Interconnection Customer must, in the decision period following the Phase 1 Study:**
 - Accept or reject its Project Cost Allocation determined in Phase 1; and
 - Satisfy the Readiness Deposit 2 requirements.
- **As described on Slide 80, the Readiness Deposit 2 is calculated as the greater of (i) the Readiness Deposit 1, and (ii) 20% of cost estimate determined in the Phase 1 Study**
- **To satisfy this requirement, Interconnection Customer must provide to the NYISO the incremental difference, if any, between the Readiness Deposit 1 amount that it previously submitted to enter the Phase 1 Study and the Readiness Deposit 2 amount.**
- **Phase 1 Study requirements are detailed in draft Attachment HH Section 40.10.**
- **The NYISO's and TOs' respective responsibilities concerning key Phase 1 Study process steps included in Section 40.10.**

Phase 2 Study/ Additional SDU Study

Phase 2 Study/Additional SDU Study

- Comparable to Class Year Part 2 Study
- Will provide Interconnection Customers with Project Cost Estimate for non-Local SUFs, SDUs and updated Local SUFs, CTOAFs, and Distribution Upgrades, as applicable
 - Interconnection Customer must accept or reject in decision period following Phase 2 (iterative decision period).
 - Upon acceptance, Interconnection Customer must post with the applicable CTO/ATO 100% of costs estimate of SUFs, SDUs, and CTOAFs (and Distribution Upgrades as applicable) identified in Phase 1 and Phase 2.
- Phase 2 Study requirements are detailed in draft Attachment HH Sections 40.11-40.15.
- **The NYISO's and TOs' respective responsibilities concerning key Phase 2 Study process steps included in Section 40.10.**

Final Decision Period

- To limit the iterations in the Final Decision Period, NYISO proposes to add an additional limitation on decisions in Subsequent Decision Rounds.
- Current tariff does not allow an Interconnection Customer to reject a Project Cost Allocation in a Subsequent Decision Round unless the Project Cost Allocation increases or Deliverable MW decrease.
- NYISO proposes that an Interconnection Customer that accepts a CTO AF and SUF Project Cost Allocation and/or SDU Project Cost Allocation will not be provided with the option to accept Revised Project Cost Allocation following a Subsequent Decision Round Period unless the Revised Project Cost Allocation is:
 - an increase of greater than ten percent (10%) in the CTO and SUF Project Cost Allocation or the SDU Project Cost Allocation; or
 - a decrease in the Interconnection Customer Deliverable MW.

Affected System Rules

Affected System Requirements

- **Order No. 2023 establishes new requirements for addressing the impact of interconnections on neighboring Affected Systems.**
 - If the host Transmission Provider identifies an Affected System impact, it will notify the Affected System Operator (ASO) and Interconnection Customer (IC) within 10 Business Days (BDs) of completion of its Cluster Study/Re-Study.
 - ASO has 20 BDs to indicate it will perform an Affected System Study, then 15 BDs to share a cost estimate/schedule of the study, then 10 BDs to provide the IC with a study agreement.
 - IC must execute the study agreement and provide a study deposit within 10 BDs.
 - ASO will have 5 BDs to identify deficiencies in the technical data, which the IC must cure within 10 BDs.

Affected System Requirements, cont.

- ASO must perform and complete the Affected System Study and provide the study report to the IC and host Transmission Provider within 150 calendar days (study delays subject to penalty)
- ASO and IC will meet to discuss the study report within 10 BDs.
- ASO will tender a construction agreement to the IC for any required upgrades within 30 calendar days of providing the study report.
- Order No. 2023 included pro forma Affected System study agreements and construction agreements.

Affected System Requirements, cont.

■ Impact on Host Transmission Provider Process:

- If an IC connecting to the host Transmission Provider's system has not received Affected System Study report from the ASO by the date that it would be required to execute an interconnection agreement with the host Transmission Provider, the host Transmission Provider shall at the IC's request extend the interconnection agreement deadline to 30 Calendar Days after receipt of the study report.
- IC can elect to proceed with interconnection agreement.
- Host Transmission Provider can also determine that delays in the agreement will cause material impact on the cost/timing of equal or lower queued projects and require execution/filing unexecuted within 30 Calendar Days.

■ Impact on Affected System Operator Process:

- The ASO will assign an Affected System Queue Position to an IC requiring an Affected System Study in its region based upon the date of execution of the study agreement.

Affected System Requirements, cont.

- **NYISO Implementation of Affected System Requirements:**
 - For Affected Systems/Affected Transmission Owners within the New York Control Area impacted by interconnections to the New York State Transmission System or Distribution System, the NYISO will address the impacts through the Cluster Study Process, which is consistent with NYISO's current process.
 - NYISO will adopt the new Order No. 2023 requirements, with modification described on subsequent slides, to function within the NYISO's new interconnection procedures in the following circumstances:
 - For Affected Systems that are neighboring Control Areas (e.g., PJM, ISO-NE) impacted by interconnection to the New York State Transmission System or Distribution System; or
 - When there are impacts on the New York State Transmission System due to an interconnection to a neighboring Control Area.

Affected System Requirements, cont.

- **NYISO Implementation of Affected System Requirements, cont.:**
 - When NYISO is the host Transmission Provider, it will notify a neighboring Control Area of an Affected System impact as soon as it becomes apparent to the NYISO:
 - Initially, NYISO will identify Affected System impacts after the Application Window closes and the projects in the Cluster have been confirmed
 - After Phase 2 analysis, additional Affected System impacts may be identified.
 - When a transmission system within the New York Control Area is an Affected System for an interconnection to a neighboring Control Area, the NYISO will, in coordination with the impacted TO or system operator located in New York, perform the process set forth in Order 2023 to study the impacts, and to identify any required upgrades, in New York.
 - The NYISO will adopt the pro forma Affected System study agreements and construction agreements, as modified to account for NYISO's process and to account for role of the TO or other system operator.

Affected System Studies

- **When NYISO is identified as an Affected System of a project in a neighboring RTO/ISO, NYISO will perform 2-part Affected System Study:**
 - Part 1: to identify if there are any impacts to the NYS Transmission System that require an upgrade
 - Part 2: to identify any required upgrades (Affected System Network Upgrades), and associated cost estimates
- **Study timeline of 300 Calendar Days**
 - Order No. 2023 provides for 150 Calendar Days for Affected System Studies (System Impact Study equivalent)
 - NYISO's proposal incorporates into an Affected System Study analyses similar to both a System Impact Study and Facilities Study and requires timeframes to perform comparable to Order No. 2023 timeline for performance of such studies.

Affected System Studies, cont.

- Study Deposit of \$100,000
- Require Interconnection Customer to accept cost allocation and post security consistent with Final Decision Period rules at the end of Phase 2 study process
 - Once an Interconnection Customer accepts cost allocation and posts security, its upgrades will be included in subsequent base cases
 - Interconnection Customer's Security will be subject to same security rules and cost responsibility rules as Security posted in the Cluster Study decision process

Anticipated Cluster Study/Affected System Notification Timeline

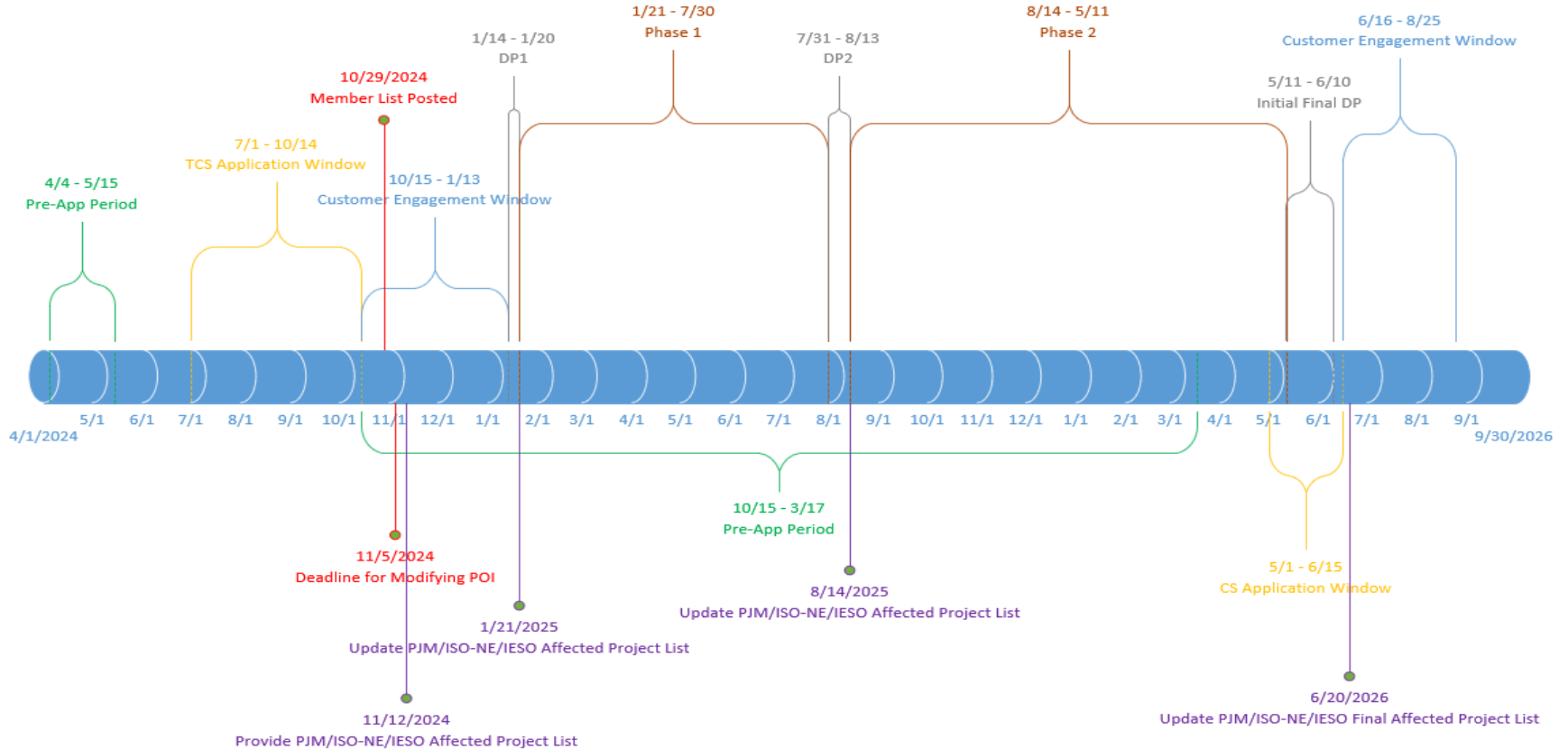

Anticipated Cluster Study/Affected System Study Timeline

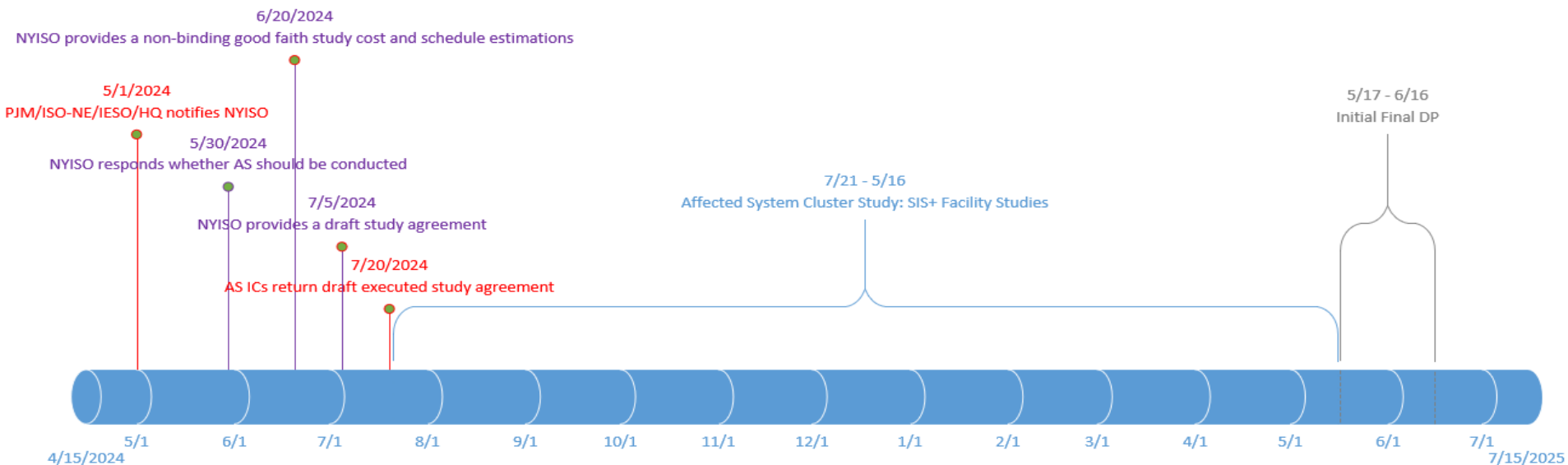

Notes:

- (1) The timeline displayed is just representative timeline.
- (2) NYISO will notify the host system within 20BDs whether the NYISO will proceed with the AS study.
- (3) After NYISO responds, NYISO will provide AS ICs study cost/schedule estimations within 15BDs.
- (4) After estimations provide, NYISO will tender draft AS study agreement to AS ICs within 10BDs.
- (5) AS ICs return signed agreement, study deposit, and study data within 10 BDs.
- (6) Study commences when all parties executed the study agreement and host system provides NYISO its system models/representation.
- (7) Study targets to complete within 300 CD after the study commences.

Study Costs - Cost Allocation

Study Costs - Cost Allocation

- Order No. 2023 provides for a study cost allocation that includes a ration for allocating the shared costs of cluster studies provided that: (i) between 10% and 50% of study costs must be allocated on a per capita basis and (ii) the remainder (between 90% and 50%) must be allocated pro rata by MW.
 - Order No. 2023 does not establish a clustered facilities study or a cost allocation for a clustered facilities study.
 - NYISO proposes to use its existing rules for allocating study costs for the Class Year Study process for purposes of the similar Cluster Study. See Att. X Section 30.13.3.
 - In particular, Cluster Projects will be responsible for Cluster Study Costs as follows:
 1. Each Cluster Project shall pay the actual cost of studying the Attachment Facilities and Distribution Upgrades for its own facility;*
 2. Each Cluster Project shall pay the actual cost of studying Local System Upgrade Facilities for its own facility;* and
 3. Each Cluster Project shall pay an equal share of all other Cluster Study costs.
- * If more than one Cluster Project contributes to the need for a particular Attachment Facility, Distribution Upgrade, or Local SUF, those Cluster Study Projects shall share equally in the cost to study that facility.

Upgrades - Cost Allocation

Upgrades - Cost Allocation

- **Order No. 2023 establishes two allocation methodologies for allocating the costs of upgrades, which depend on whether the upgrades are located at the POI Substation, including switchyard stations (i.e., the “Substation Network Upgrades”) or other upgrades (“System Network Upgrades”).**
 - The costs of Substation Network Upgrades (i.e., NYISO’s Local SUFs) and interconnection facilities are to be allocated on a per capita basis for each project using the facilities.
 - The cost of System Network Upgrades (i.e., non-Local SUFs) are to be allocated using a proportional impact method.
 - The Transmission Provider is required to describe how each type of upgrade would be allocated among developers in the Cluster (e.g., allocation for upgrades caused by voltage support, short-circuit analysis, etc.).
- **The NYISO proposes to continue to use a proportional impact method.**
 - The NYISO determines proportional impacted based on the trigger for the upgrade: (i) for thermal upgrades: MW impact; (ii) for short circuit upgrades: ampere impact; (iii) for stability upgrades: ampere impact; (iv) for voltage upgrades: voltage deviation impact; and (v) for protection/communication upgrades: equally per project.

Incorporating Small Generating Facilities into the Cluster Study Process

Small Generating Facilities in the Cluster Study Process

- **While not explicitly required by Order No. 2023, it would be beneficial to incorporate Small Generating Facilities into the Cluster Study Process:**
 - More efficient and streamlined interconnection process
 - Single set of rules
 - Base case alignment
 - May expedite the total study process for Small Generating Facilities
 - Study costs in Cluster Study process are expected to align with historical study costs in the Small Generator Interconnection Procedures and even potentially less depending on the MW size (deposits in the Cluster Study process are calculated based on MW)
- **NYISO has received favorable feedback for incorporating Small Generating Facilities into the Cluster Study Process and intends to include this change in compliance filing.**
- **Transition Rule for Small Generating Facilities under review pending Stakeholder feedback.**

Interconnection Agreement

Interconnection Agreement (IA)

- NYISO will tender to Developer a draft interconnection agreement as soon as practicable after completion of the final decision period at conclusion of Cluster Study Phase 2.
- Negotiation period will be 6 months (unless all parties agree to extend this period).
- Developers and TOs will still have the option of using an E&P Agreement to start on engineering and procurement during the negotiation of the IA, which agreement will be superseded by the IA.
- NYISO proposes to clarify it will not tender the execution version of the IA or file it unexecuted at FERC until demonstrates continued Site Control and one of the following milestones, in relation to the execution of the IA:
 - the execution of a contract for the supply or transportation of fuel to the Generating Facility;
 - the execution of a contract for the supply of cooling water to the Generating Facility;
 - execution of a contract for the engineering for, procurement of major equipment for, or construction of, the Generating Facility;
 - execution of a contract (or comparable evidence) for the sale of electric energy or capacity from the Generating Facility; or
 - application for an air, water, or land use permit.

Interconnection Agreement (IA) (cont.)

- **NYISO revised Large Generator Interconnection Agreement – now Standard Interconnection Agreement - to apply to all Generating Facilities and Cluster Study Transmission Projects. NYISO also adopted conforming revisions from new interconnection procedures in IA and made certain edits directed by Order 2023.**
- **NYISO developed single and multi developer pro forma construction agreements for engineering, procurement, and construction of upgrades not addressed in IA.**
- **Construction agreements based on engineering, procurement, and construction rules in NYISO IA and consistent with prior EPC Agreements negotiated among NYISO, NYTOs, and developers.**

Interconnection Agreement (IA), cont.

- **Small Generating Facilities subject to a facilities study under the Small Generator Interconnection Procedures will use the pro forma Small Generator Interconnection Agreement.**
- **Small Generating Facilities that proceed to the Cluster Study Process will be subject to an updated standard interconnection agreement.**

Technological Advancements Prescribed in Order No. 2023

Co-Located Generating Facilities Behind Single POI

- **Order No. 2023 requires Transmission Providers to allow more than one generating facility to co-locate on a shared site behind a single POI and share a single IR.**
 - Co-located generating facilities can be owned by a single developer with multiple generating facilities sharing a site or by multiple developers that have a contract/agreement that allows for shared land use.
- **NYISO's interconnection procedures already provide for Co-Located Shared Resources. NYISO intends to retain these requirements in new procedures**
- **Order 2023 provides that generating facilities with different terminal voltage levels would need to submit separate IRs.**
 - NYISO proposes to request an independent entity variation to allow a single IR for a generating facility interconnecting via two kV levels in the same Capacity Region.

Generating Facility Additions

- **Order No. 2023 requires Transmission Provider to evaluate the proposed addition of a generating facility at the same POI prior to deeming such an addition a material modification if the addition does not change the originally requested interconnection service level. This requirement does not change Transmission Provider's ability to find the requested change material if it impacts cost/timing of an equal or lower queued developer.**
- **NYISO currently permits a non-material modification as long as the total requested ERIS does not increase by more than 2 MW and the requested CRIS does not increase.**
- **NYISO intends to retain these requirements in new procedures**
- **FERC established its requirements for pre-facilities study agreement changes (after which the request can be found a material modification without review.)**
 - **NYISO intends to request an independent entity variation to limit modifications during the Cluster Study Process to the 5 Business Day-period after publication of the Cluster member list during the Customer Engagement Window.**

Consideration of Enumerated Alternative Transmission Technologies in Interconnection Studies

- **Order No. 2023 required Transmission Providers to evaluate the following list of alternative transmission technologies: static synchronous compensators, static VAR compensators, advanced power flow control devices, transmission switching, synchronous condensers, voltage source converters, advanced conductors, and tower lifting.**
 - Transmission Provider to determine, in its sole discretion, whether such technology should be used consistent with good utility practice, applicable reliability standards, and other applicable reliability requirements.
 - Transmission Providers must include an explanation of the results of the evaluation for feasibility, cost, and time savings in the applicable study report.
 - The new rules mandate a process for evaluating the alternatives, not a particular outcome or presumption.
- **NYISO intends to adopt reforms consistent with Order No. 2023.**

Operating Assumptions for Electric Storage Resources in Interconnection Studies

- **Order No. 2023 required Transmission Providers, at the request of developers, to use operating assumptions in interconnections studies (for ERIS and NRIS) that reflect the proposed charging behavior of electric storage resources (whether stand alone, co-located generating facility, or part of hybrid generating facility)**
 - *i.e.*, whether the interconnecting generating facility will or will not charge during peak load conditions – unless good utility practice, including applicable reliability standards, otherwise requires the use of different operating instructions.
 - Transmission Providers to memorialize such operating requirements in the LGIA or require control technologies.
- **NYISO will seek an independent entity variation not to apply this requirement.**
 - Would add significant new complexity and time to the interconnection study process
 - Not consistent with NYISO’s market rules and would create inconsistent planning rules across different types of intermittent resources
 - Could require NYISO to incorporate assumptions inconsistent with a resource’s likely performance.
 - Could adversely impact the NYISO’s ability to plan for certain system scenarios, including rare system conditions, which could result in the NYISO not identifying SUFs required to maintain system reliability
- **While certain developers have voiced concerns over the potential for unnecessary System Upgrade Facilities absent the use of such operating assumptions, under NYISO’s Minimum Interconnection Standard, upgrades are only required if adverse reliability impacts cannot be mitigated through normal operating procedures (including re-dispatch).**
- **To address stakeholder concerns regarding the inability to use re-dispatch to mitigate the need for System Upgrade Facilities on transmission facilities not secured by the NYISO, NYISO proposes to address issues on **transmission** facilities 100kV or above as described on the following two slides.**

Energy Storage Operating Assumptions

- NYISO proposes to use the following as Normal Operating Procedures to mitigate reliability impacts triggered by storage, solar and wind projects:
 - For transmission elements not secured in NYISO market systems (BMS): Allow developers of Storage, Solar, and Wind projects causing overloads on transmission elements operated at 100+kV and for transformers where the low side connection is operated at 100+ kV to elect to move forward without correcting thermal overloads in MIS.
 - The NYISO will keep a record of the overloads that were observed in the study process.
 - When the resources are integrated into the market system models, NYISO will follow the process outlined in the T&D manual to potentially secure more facilities in BMS.
 - If the NYISO is unable to add an overloaded element as BMS secured because it does not meet the criteria outlined in the T&D manual and a limitation to the output or withdrawals of the resource is needed to secure the thermal overload, then in real-time operations the NYISO will redispatch the resource by issuing an Out-of-Merit instruction (a type that avoids a DAMAP payment), and/or a Wind and Solar Output Limit to a Wind or Solar project, to resolve the overload.
 - If and to the extent an energy storage resource's (ESR's) injections and withdrawals are reduced via an Out-of-Merit instruction to prevent an overload on a non-ISO secured, 100kV+ transmission facility where an overload was observed in the study process, then the ESR will not be eligible to receive a Day-Ahead Margin Assurance Payment (DAMAP).
 - NYISO has included proposed revisions to Services Tariff Section 25 to address this scenario.
 - Wind and solar Generators are never eligible to receive DAMAP. See MST 25.2.2.1(iii)

Energy Storage Operating Assumptions

- **As explained on prior slides, the NYISO proposes to develop and employ Normal Operating Procedures to mitigate reliability impacts triggered by storage, solar and wind projects on TO-secured, 100kV+ transmission facilities.**
- **However, there will be instances where OOM redispatch does not provide an adequate solution and upgrades will still be necessary, consistent with the relevant TO's requirements.**
 - This is expected to be the case if the 100kV+ transmission facility to which an ESR, wind or solar project is interconnecting is not considered by NERC to be a Bulk Electric System (BES) Facility.
 - For example, a 100+kV transmission facility which is only a radial connection to supply load or “load networks” may not constitute BES facilities.
 - In addition, an interconnection study may identify a concern that redispatch is not able to fully address. In those cases, upgrades may be required.
 - The NYISO must maintain its authority to coordinate with the TOs to identify 100kV+ transmission facilities where upgrades must be required in the interconnection process.

Availability of Surplus Interconnection Service

- **Order No. 2023** required Transmission Providers to allow developers to access the surplus interconnection service process once original developer has an executed LGIA (or requests it be filed unexecuted), to enable other generating facilities to use unused interconnection service earlier than currently allowed.
- This requirement does not apply to the NYISO's interconnection procedures.
- NYISO received independent entity variation from FERC in Order No. 845 compliance filing as the surplus interconnection service concept does not apply in NYISO.

Modeling and Ride-Through Requirements for Non-Synchronous Generating Resources

- **Order No. 2023** required that each developer requesting to interconnect a non-synchronous generating facility in LGIP or SGIP is required to submit to the Transmission Provider:
 1. a validated user-defined RMS positive sequence dynamic model;
 2. an appropriately parameterized generic library RMS positive sequence dynamic model, including a model block diagram of the inverter control system and plant control system, that corresponds to a model listed in a new table of acceptable models or a model otherwise approved by WECC; and
 3. a validated EMT model, if the Transmission Provider performs an EMT study as part of the interconnection study process.
- **NYISO intends to adopt the reforms consistent with Order No. 2023 with Independent Entity Variations to the extent necessary for implementation.**

Ride-Through Requirements for Non-Synchronous Generating Resources

- **Order No. 2023 required that, during abnormal frequency conditions and voltage conditions within the “no trip zone” defined by NERC Reliability Standard PRC-024-3 (or successor), the non-synchronous generating facility must ensure that, within any physical limitations of the generating facility, its control and protection settings are configured or set to:**
 1. continue active power production during disturbance and post disturbance periods at pre-disturbance levels unless providing primary frequency response or fast frequency response;
 2. minimize reductions in active power and remain within dynamic voltage and current limits, if reactive power priority mode is enabled, unless providing primary frequency response or fast frequency response;
 3. not artificially limit dynamic reactive power capability during disturbances; and
 4. return to pre-disturbance active power levels without artificial ramp rate limits if active power is reduced, unless providing primary frequency response or fast frequency response.

Ride-Through Requirements, cont.

- In addition, large generating facilities are required to stay connected to and synchronized with the transmission system during system disturbances within under-voltage and over-voltage conditions.
- Order No. 2023 required that all newly interconnecting large generating facilities are required to provide frequency and voltage ride through capability consistent with any standards and guidelines that are applied to other generating facilities in the balancing authority area on a comparable basis.
- NYISO intends to adopt the reforms consistent with Order No. 2023 and applicable NYSRC Reliability Rules.

Order No. 2023 Penalty Structure

Order No. 2023 Penalty Structure

- NYISO **and others** Requested Rehearing of several aspects of Order No. 2023, including the imposition of penalties for study delays.
- In addition, **multiple** appeals of FERC’s denial of rehearing **are** pending in the D.C. Circuit Court of Appeals (FERC may issue a supplemental order addressing the substance of the requests for rehearing).
- The most significant concerns raised on rehearing regarding the penalty structure included in Order No. 2023:
 - Penalties are disproportionately punitive or wholly ineffectual with perverse incentives to prioritize study speed over study quality and system reliability.
 - NYISO can only pay penalty costs using funds that are ultimately collected from its customers, denying recovery of such costs is disproportionately punitive.
 - Applying “one-size” fits all penalty regime is unduly discriminatory.
 - **Denial of rate recovery by FERC could cause insolvency since NYISO, as a 501(c)3 organization, has no source of revenue to fund penalty payments other than Rate Schedule 1.**

Order No. 2023 Penalty Structure

- **Related to penalties, the NYISO requested FERC grant rehearing to:**
 - Permit each transmission provider to establish firm interconnection study deadlines that are reasonable and realistic in light of the study scopes and circumstances in each region instead of one-sized-fits-all timeframes;
 - Reverse the Order No. 2023 determination to apply its strict liability penalty regime to the NYISO and similarly situated RTOs and ISOs that have no ability to recover penalty costs except using funds that come from customers;
 - Clarify, if it retains the application of study penalties for RTOs/ISOs the recovery mechanism for RTO/ISOs to recover penalty costs;
 - **Provide stronger and more balanced due process protections; and**
 - Permit penalty waivers in cases in which it is difficult to identify the parties to blame for missed study deadlines.
- ~~In light of the pending Requests for Rehearing and D.C. Circuit appeal, NYISO is not proposing a compliance approach to this aspect of Order No. 2023 at this time; however, the NYISO will address this issue with stakeholders based on the status of those proceedings prior to the compliance filing.~~

NYISO's Proposed Approach to Penalties

- NYISO will request an Independent Entity Variation under which it would not adopt Order No. 2023's *pro forma* penalty rules.
- Instead, the NYISO would propose to implement enhanced informational reports on study metrics that will be posted on NYISO's website at the end of each Phase of the Cluster Study and on an annual basis for Affected System Studies.
- If there are delays in Phase 1 and/or Phase 2 or for an Affected System Study, NYISO will submit a report to FERC at the end of Phase 2 or the Affected System Study describing the reasons for delay.

NYISO's Proposed Approach to Penalties

- Order No. 2023 specified that penalty rules would not go into effect until the third study cluster cycle after a compliance filing is accepted.
- In the NYISO's case, this means that any missed study deadline penalty rules would not be implemented until 2027 or even 2028.
- The NYISO's proposed independent entity variation would therefore not have any practical impacts for several years.
- FERC may provide needed guidance on the *pro forma* penalty rules, or even modify them, as a result of the rehearing/appeal process.

Next Steps

Next Steps

- **Compliance Filing Deadline: April 3, 2024**

Questions?

Roles of the NYISO

- **Reliable operation of the bulk electricity grid**
 - Managing the flow of power on 11,000 circuit-miles of transmission lines from hundreds of generating units
- **Administration of open and competitive wholesale electricity markets**
 - Bringing together buyers and sellers of energy and related products and services
- **Planning for New York's energy future**
 - Assessing needs over a 10-year horizon and evaluating projects proposed to meet those needs
- **Advancing the technological infrastructure of the electric system**
 - Developing and deploying information technology and tools to make the grid smarter

Our Mission & Vision



Mission

Ensure power system reliability and competitive markets for New York in a clean energy future



Vision

Working together with stakeholders to build the cleanest, most reliable electric system in the nation